

This publication is available on the USA Volleyball website.

© 2023 USA Volleyball

All rights reserved. No part of this book may be reproduced or transmitted in any form by any means, electronic, mechanical, photocopying, recording, or otherwise, without the prior written permission of the publisher. For more information on getting permission for reprint and excerpt, contact:

4065 Sinton Rd, Suite 200

Colorado Springs, Colorado 80907

Phone: (719) 228-6800

Fax: (719) 228-6899

[postmaster@usav.org](mailto:postmaster@usav.org)

ISBN: 978-0-9914950-6-1





Rules of the Game as authorized by the International Volleyball Federation (FIVB at the 37th FIVB World Congress, 2023).

Published by USA Volleyball.



USA Volleyball has officially approved the modifications presented in this document in order to promote the sport and encourage continuity of play at the various organizational, local and recreational levels across the country.

For the official international rules of the game, which are used worldwide and developed and approved by the FIVB, please visit [www.fivb.org](http://www.fivb.org) or our web site at [www.usavolleyball.org](http://www.usavolleyball.org).

USA Volleyball embraces this view, joining with all of its global partners to enable pleasurable participation from the broadest base of recreational play to the highest levels of international competition.

Volleyball can enrich the lives of all who play and watch it. It should be fun.

**WE COMMIT THE RULES TO THIS END.**



## **ACKNOWLEDGMENTS**

The Rules Commission and USA Volleyball would like to express their appreciation to the many individuals and organizations for their assistance in the editing of and providing information for this publication.

Official Hand Signals courtesy of the Federation Internationale de Volleyball, ©2021 FIVB.

Diagrams 1-12 reproduced by authorization of the Federation Internationale de Volleyball, ©2021, FIVB.

Special thanks go to Barbara Grice, Brian Hemelgarn, Matt Podschweit, Stephen Shepard, Bill Stanley and Julie Voeck.

# Table of Contents

## SECTION I

### PREFACE

Modifications.....	12
Rules Interpretation .....	13
Information For Hearing-Impaired Volleyball Players .....	13
Information For Physically Challenged Volleyball Players .....	13
USA Volleyball Rules Commission .....	14
USA Volleyball Staff Liaison .....	15
Significant Rules Changes And Clarifications.....	16
Summary Of Editorial Updates .....	18
Game Characteristics .....	19
Philosophy Of Rules And Refereeing .....	20
Ball Handling Guidelines .....	22
Spectator/Parent Conduct Guidelines At USA Volleyball Events.....	22

## SECTION II

### THE GAME

#### Chapter 1

Facilities And Equipment

Rule 1. Playing Area.....	26
Rule 2. Net And Posts (Diagram 3) .....	28
Rule 3. Balls.....	31

#### Chapter 2

Participants

Rule 4. Teams .....	33
Rule 5. Team Leaders.....	37

#### Chapter 3

Playing Format

Rule 6. To Score A Point, To Win A Set And The Match .....	40
Rule 7. Structure Of Play .....	42

#### Chapter 4

Playing Actions

Rule 8. States Of Play .....	48
Rule 9. Playing The Ball.....	50
Rule 10. Ball At The Net.....	52

Rule 11. Player At The Net.....	53
Rule 12. Service .....	55
Rule 13. Attack Hit.....	58
Rule 14. Block.....	59

## Chapter 5

Interruptions, Delays And Intervals

Rule 15. Interruptions .....	62
Rule 16. Game Delays.....	67
Rule 17. Exceptional Game Interruptions .....	68
Rule 18. Intervals And Change Of Courts.....	70

## Chapter 6

The Libero Player

Rule 19. The Libero Player .....	71
----------------------------------	----

## Chapter 7

Participants' Conduct

Rule 20. Requirements Of Conduct.....	76
Rule 21. Misconduct And Its Sanctions .....	76

### SECTION III

#### THE GAME OFFICIALS

## Chapter 8

Referees.....	82
Rule 22. Refereeing Corps And Procedures .....	82
Rule 23. 1st Referee .....	83
Rule 25. Scorer.....	88
Rule 26. Assistant Scorer.....	89
Rule 27. Line Judges.....	90
Rule 28. Official Signals .....	91

### SECTION IV

#### DIAGRAMS, U-VOLLEY, CO-ED & PARAVOLLEY

Court Diagrams.....	94
Official Hand Signals.....	105
Definitions .....	117
U-Volley Rules .....	119
Co-Ed Rules .....	119
Guide To Physically Challenged Volleyball.....	123

## SECTION V

### OFFICIATING

Referee Techniques .....	130
Referee Points Of Emphasis .....	138
Basic Match Procedures For Referees .....	142

## SECTION VI

### USAV SCORING INSTRUCTIONS & SCORE SHEETS

General Scoring Procedures .....	151
Deciding Set Scoring Procedures .....	183
National Event Scoring Procedures .....	198
Assistant Scorer And Libero Control Sheet Procedures .....	200

## SECTION VII

### BASIC USAV TOURNAMENT PROCEDURES

Guidelines For Conducting Indoor Tournaments/Leagues .....	246
Guidelines For Dealing With Blood .....	255
Concussion Guidelines.....	256
American Sign Language (ASL) Interpreter Guidelines .....	257
Abbreviations .....	257
Metric Conversions .....	258
Index.....	262









---

**SECTION I**

---

**PREFACE**

## MODIFICATIONS

For all designated international competitions, the FIVB rules will be fully in effect. In addition, FIVB rules are used at the highest levels of USAV competition (such as Adult Open Divisions and the All-Star Championship) unless otherwise noted in the specific competitions regulations. USAV modifications and clarifications to the FIVB rules are outlined in gray boxes and apply to all other levels of competition. When a USAV modification is fully in effect and supersedes the corresponding FIVB rule, only the USAV modification is listed. For example, USAV 4.3.3 supersedes FIVB Rule 4.3.3:

USAV RULE EXAMPLE:

**USAV 4.3.3:** The players' jerseys must be numbered in a permanent manner from 1 to 99 using Arabic numerals. Duplicate numbers are not allowed. (see also USAV 4.3.3.2).

USAV RULE MODIFICATION EXAMPLE:

**USAV 4.3.3.1:**

- a. Uniform numbers must be clearly visible and centered side to side on the front and back of the jersey. Numbers are recommended to be placed on the upper half of the jersey. Numbers may not extend below the player's waist and may not be tucked into the uniform bottom.

NEW RULE EXAMPLE:

**USAV 19.2 :**

- d. When two Liberos are used, both Liberos can be in uniforms different from each other and from the rest of the team.

USA Volleyball recognizes that there are circumstances where grassroots development, sport development, safety, or insurance requirements would indicate a need for a temporary rule modification (e.g., the number of substitutions might be expanded to include more participants at a school or recreational level).

Acknowledging that a rule may not be changed, in instances where the USAV member organizations feel that the promotion of the sport would be enhanced by temporary adjustments, they are encouraged to promote the advancement of the sport.

Suggestions for rules changes, modifications, or temporary adjustments for inclusion in this document may be transmitted through members of the Rules Commission, a regional officials' chairperson, or regional commissioners during the season. Explanation and rationale of proposed modifications must be received by the USAV Rules Commission Chair before February 1 if they are to be considered at the annual meeting of the Rules Commission.

## **RULES INTERPRETATION**

Questions regarding interpretation of the current rules and practices may be addressed, by email, to USA Volleyball Indoor Rules Interpreter Bill Stanley (Email: vbinterp@usav.org). All inquiries will receive replies. Some queries may involve consultations, but answers will be forwarded as soon as possible.

For information relevant to the interpretation and application of the rules-specific match situations, please consult the USA Volleyball Casebook web site: at:

<https://usavolleyball.org/resources-for-officials/rulebooks-and-interpretations/>

## **INFORMATION FOR HEARING-IMPAIRED VOLLEYBALL PLAYERS**

For additional information on the USA Deaf Volleyball Association or USA Deaf Sports Federation, contact:

### **USA Deaf Sports Federation**

PO Box 22011, Santa Fe, NM 87502-2011

Email: [homeoffice@usdeafsports.org](mailto:homeoffice@usdeafsports.org)

Web Site: [www.usdeafsports.org/sports/VO](http://www.usdeafsports.org/sports/VO)

TT: (605) 367-5761, (605) 367-5760, FAX: (605) 782-8441

Dial 711 for voice calls and give relay operator the TT number above.

To obtain a copy of Volleyball in American Sign Language, which illustrates more than 40 of the most important volleyball terms, contact USA Volleyball at 855-USVOLLEY or [info@usav.org](mailto:info@usav.org).

## INFORMATION FOR PHYSICALLY CHALLENGED VOLLEYBALL PLAYERS

For additional information on the Men's and Women's Sitting Volleyball National Programs for the physically challenged, contact:

### **Bill Hamiter**

High Performance Director, Sitting Program Head Coach  
Women's National Sitting Team  
Phone: (405) 974-3138; Email: bill.hamiter@usav.org

For additional information on grassroots programs (find a place to play, create a new program, etc.), contact:

### **Elliot Blake**

Sitting Volleyball Manager  
Phone: (405) 974-3153; Email: elliot.blake@usav.org.

## INFORMATION FOR SPECIAL OLYMPICS VOLLEYBALL

For additional information on Special Olympics Traditional, Modified and Unified® Sports Team Volleyball and Individual Skills Volleyball Programs, please contact:

### **Special Olympics North America**

Craig Pippert  
Phone: (919) 785-0702; FAX: (919) 782-3311;  
Email: cpippert@specialolympics.org

## USA VOLLEYBALL RULES COMMISSION

- \* Chair: Julie Voeck (Badger Region), Email: jvoeck@runbox.com
- \* FIVB Rules of the Game Commission: Ken Taylor (Southern California Region), Email: ktaylor69@cox.net
- \* USA Volleyball Indoor Rules Interpreter: Bill Stanley (Great Plains Region), Email: vbinterp@usav.org
- \* USA Volleyball Beach Rules Interpreter: Tony Chan (Southern California Region), Email: beachinterp@usav.org
- \* USA Volleyball Indoor Regional Volleyball Association Representative: Kevin Wendelboe (Carolina Region), Email: ceo@carolinaregionvb.org
- \* USA Volleyball Beach Regional Volleyball Association Representative: Keith Murlless (Rocky Mountain Region), Email: kmurlless@gmail.com

- \* Junior Indoor Girls Representative: Eric Lazowski (Lakeshore Region),  
Email: Eric.Lazowski@gmail.com
- \* Junior Indoor Boys Representative: Brian Sharkey (Badger Region),  
Email: brian@badgervolleyball.org
- \* Junior Beach Representative: Mary Andrew (Florida Region),  
Email: mary@floridavolleyball.org
- \* World ParaVolley: Joe Campbell (Lone Star Region), Email: iokepa1@yahoo.com

\*10 voting members

**NON-VOTING REPRESENTATIVES**

- NCAA Women's Representative: Anne Pufahl,  
Email: poofervbr@gmail.com
- NFHS Representative: Lindsey Atkinson, Email: latkinson@nfhs.org
- PAVO Representative: Brian Hemelgarn, Email: Hemelgarn@ovr.org

**INVITED GUESTS**

- AAU Representative: OPEN
- NAIA Men's and Women's Representative: Tom Young,  
Email: thomas.young@mobap.edu
- NCAA Men's Representative: John Kosty, Email: kosty@stanford.edu
- NCVF Representative: Dan Kitchel, Email: dkitchel@ncvfvolleyball.org
- Special Olympics, Incorporated: Rick Laskey,  
Email: rlaskey@earthlink.net
- YMCA Representative: OPEN

**USA VOLLEYBALL STAFF LIAISON**

**Director of Officials Development:**

**Pati Rolf,**

Cell: 262-510-6771

Email: pati.rolf@usav.org

## SIGNIFICANT RULES CHANGES AND CLARIFICATIONS

**USAV 4.3.3.1a:** Uniform numbers must be clearly visible and centered side to side on the front and back of the jersey. Numbers are recommended to be placed on the upper half of the jersey. Numbers may not extend below the player's waist and may not be tucked into the uniform bottom.

**USAV 5.1.2.1, added:** Judgment decisions are not subject to protest. A protest related to a judgment decision may result in a penalty (red card) being assessed to the coach.

**USAV 5.2.3.4:** During the match, the coach may give instructions to players on the court while standing or walking within the free zone in front of his/her team's bench from the extension of the attack line up to and including the warm-up area, without disturbing or delaying the match. The coach must not obstruct the view of the line judges.

**USAV 5.3.1:** One assistant coach at a time may stand to give instructions to the players on the court but has no right to intervene in the match. During play, the assistant coach may give these instructions while standing or walking within the free zone in front of his/her team's bench from the extension of the attack line up to and including the warm-up area, without disturbing or delaying the match. The assistant coach must not obstruct the view of the line judges.

**New USAV 12.4.4a:** Once the serving action is initiated, including an underhand serve, if the server tosses the ball and then catches it or allows it to fall to the floor, this is considered a service tossing error, including a ball that touches the server as it falls.

**USAV 12.4.4b:** After a service tossing error, the referee must authorize the service again (re-serve) and the server must execute it within the next 8 seconds.

Rule 12.5.1: The players of the serving team must not prevent their opponent, through individual or collective screening, from seeing the service hit and the flight path of the ball. Should either be visible to the receiving team, this is not a screen.

**USAV 12.5.2:** A player or group of players of the serving team make(s) a screen by waving arms, jumping or moving sideways, during the execution of the service, or by standing grouped, and in so doing hides both the service hit and the flight path of the ball until the ball reaches the vertical plane of the net.



Rule 14.3: In blocking, the player may place his/her hands and arms beyond the net, provided that this action does not interfere with the opponent's play. Thus, it is not permitted to touch the ball beyond the net before an opponent has executed an attack hit.

Rule 14.6.1: The blocker touches the ball in the OPPONENT'S space before the opponent's attack hit.

**New USAV 19.2d:** When two Liberos are used, both Liberos can be in uniforms different from each other and from the rest of the team.

**USAV 24.2.7d:** During the match, the coach or captain may request verification of the number of team substitutions or time-outs. If incorrect information is provided by the 2nd referee and the team acts directly upon this misinformation resulting in an illegal substitution (per USAV 15.9.1) or an excessive time-out, the referee's error will be corrected with no penalty or sanction assessed to the team. If an illegal (excessive) substitution does not result, the substitution may still be withdrawn prior to the next serve without sanction or penalty.

## SUMMARY OF EDITORIAL UPDATES

**USAV 4.3.3.1a:** clarifies jersey number placement

**USAV 5.1.2.1:** adds possible penalty for protest related to judgment decisions

**USAV 5.2.3.4:** removes coaching restriction line

**USAV 5.3.1:** removes coaching restriction line

**USAV 12.4.4a:** clarifies 14 and younger reserve rule

**USAV 12.4.4b:** change 5 seconds to 8 seconds for 14 and younger servers

Rule 12.5.1: now states “service hit” instead of “server” to determine a screen

**USAV 12.5.2:** “server” changed to “service hit”

Rule 14.3: clarifies a blocker may not touch the ball in the opponent’s space before the opponent’s attack hit

Rule 14.6.1: clarifies it is a fault to block the ball in opponent’s space before the attack hit; removes “before or simultaneously with opponent’s attack hit”

**USAV 17.1.1:** adds reference to Concussion Guidelines

**USAV 19.2d:** clarifies when a team uses two Liberos, they do not need to be dressed alike

**USAV 24.2.7d:** adds clarification for withdrawing a substitution request when incorrect information is provided to the coach

Revised Diagram 11 – Referees’ Official Hand Signals

Change of Courts – deleted “previous” from “previous protocol of changing courts”

Referee Techniques #20h – clarifies 2nd referee touch information

Referee Points of Emphasis #3 & #4 – clarifies coaches’ location; removal of coaching restriction line

Basic Match Procedures #11 – added possible penalty to protest procedure

S3.6.6: clarifies review of line-up sheets by scorer

S3.8.1: clarifies duplicate numbers on line-up sheet may be corrected before a set

S6.2: clarifies Libero serving when two Liberos are used by a team

S7.3: clarifies 8 seconds are allowed for all serves, including 14 and younger

S10.1.1, S10.2.1, S13.6.1a, S13.7.1a: clarifies that exceptional substitution is permitted for expelled/disqualified player

S13.6.1c, S15.2.1c: clarifies expelled player or Libero must remain seated on bench

S20.2, S20.3.1, A5.7, A5.8, A5.9, A5.10: add clarifications when change of courts is used

## GAME CHARACTERISTICS

Volleyball is a sport played by two teams on a playing court divided by a net. There are different versions available for specific circumstances in order to offer the versatility of the game to everyone.

The object of the game is to send the ball over the net in order to ground it on the opponent's court, and to prevent the same effort by the opponent. The team has three hits for returning the ball (in addition to the block contact).

The ball is put in play with a service: hit by the server over the net to the opponents. The rally continues until the ball is grounded on the playing court, goes "out" or a team fails to return it properly.

In Volleyball, the team winning a rally scores a point (Rally Point System). When the receiving team wins a rally, it gains a point and the right to serve, and its players rotate one position clockwise.

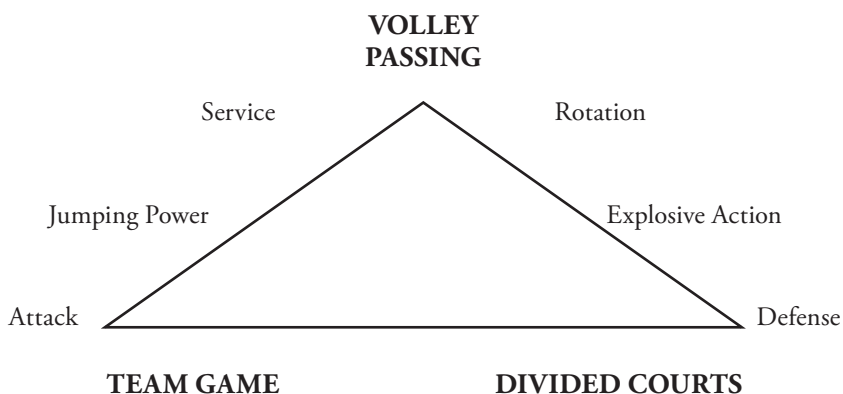

# PHILOSOPHY OF RULES AND REFEREEING

## INTRODUCTION

Volleyball is one of the most successful and popular competitive and recreational sports in the world. It is fast, it is exciting, and the action is explosive. Yet Volleyball comprises several crucial overlapping elements whose complementary interactions render it unique among rally games:

In recent years, the FIVB has made great strides in adapting the game to a modern audience.

This text is aimed at a broad Volleyball public – players, coaches, referees, spectators or commentators – for the following reasons:

Understanding the rules better allows better play – coaches can create better team structure and tactics, allowing players full reign to display their skills;

Understanding the relationship between rules allows officials to make better decisions.

This introduction at first focuses on Volleyball as a competitive sport, before setting out to identify the main qualities required for successful refereeing.

Volleyball is a Competitive Sport

Competition taps latent strengths. It exhibits the best of ability, spirit, creativity and aesthetics. The rules are structured to allow all of these qualities. With a few exceptions, Volleyball allows all players to operate both at the net (in attack) and in the back of the court (to defend or serve).

William Morgan, the game's creator, would still recognize it because Volleyball has retained certain distinctive and essential elements over the years. Some of these it shares with other net/ball/racquet games:

- service
- rotation (taking turns to serve)
- attack
- defense

Volleyball is, however, unique amongst net games in insisting that the ball is in constant flight – a flying ball – and by allowing each team a degree of internal passing before the ball must be returned to the opponents.

The introduction of a specialist defensive player – the Libero – has moved the game forward in terms of rally length and multi-phase play. Modifications to the service rule have changed the act of service from simply a means of putting

the ball in play to an offensive weapon.

The concept of rotation is entrenched to allow for all-around athletes. The rules on player positions must permit teams to have flexibility and to create interesting developments in tactics. Competitors use this framework to contest techniques, tactics and power. The framework also allows players a freedom of expression to enthuse spectators and viewers. And the image of Volleyball is increasingly a good one.

### THE REFEREE WITHIN THIS FRAMEWORK

The essence of a good official lies in the concept of fairness and consistency:

- To be **fair** to every participant;
- To be **viewed** as fair by the spectators.

This demands a huge element of trust – the referee must be trusted to allow the players to entertain:

- by being accurate in his/her **judgment**;
- by **understanding why the rule is written**;
- by being an **efficient organizer**;
- by allowing the competition to flow and by **directing** it to a conclusion;
- by being an **educator** – using the rules to penalize the unfair or admonish the impolite;
- by **promoting** the game – that is, by **allowing the spectacular** elements in the game to shine and the best players to do what they do best: **entertain** the public.

Finally, we can say that a good referee will use the rules to make the competition a fulfilling experience for **all** concerned.

To those who have read thus far, view the rules that follow as the current state of development of a great game, but keep in mind why these preceding few paragraphs may be of equal importance to you in your own position within the sport.

**GET INVOLVED! KEEP THE BALL FLYING!**

## BALL HANDLING GUIDELINES

In accordance with the spirit of the rules and to encourage longer rallies and spectacular actions, only the most obvious violations will be whistled. Therefore, when a player is not in a very good position to play the ball, the 1st referee will be less severe in his/her judgment of ball handling faults. For example: 1) A player running to play the ball or forced to make a very quick action to reach the ball in order to set. 2) A player is forced to run or make very quick actions to play a ball after it has rebounded from the block or from another player. 3) The first team contact may be freely made except if the player catches or throws the ball.

## SPECTATOR/PARENT CONDUCT GUIDELINES AT USA VOLLEYBALL EVENTS

The following guidelines are intended to encourage positive spectating experiences in an enthusiastic, supportive environment for athletes, coaches, officials, and fellow spectators.

1. USAV Volleyball has a “zero tolerance” policy for unsporting conduct at local, regional, and national events.
2. Harassment, intimidation, or unsporting words or actions directed towards other spectators, match participants, tournament staff, officials, including line judges and scorers, may result in removal from the event. Attendance at future events may also be impacted.
3. A current membership with USA Volleyball is required to participate in any game or game-like activities.
4. Law enforcement, security personnel, and USA Volleyball Event Arbitrators (the “Green Shirts”) play an important role in ensuring a safe, fair environment for our young athletes and should be considered important members of the tournament staff.
5. Generate goodwill and good sportsmanship by being polite and respectful to others attending the event.
6. The Event Director and/or Program Administrator must be notified when any illegal activity is witnessed.
7. Spectator seating around the courts is for the primary use of those watching the match in progress. Spectators may rightfully choose to remain in a seat for an entire match without switching sides of the court.
8. Alcohol may not be consumed courtside at any USA Volleyball Youth/

Junior volleyball event.

9. Club directors and coaches have a responsibility to address unsporting conduct, words, or actions, by spectators or parents associated with their club.
10. **WARNING!** Injury from flying objects incidental to the sport of volleyball may occur. Attend at your own risk. Please pay close attention to your surroundings and be alert at all times, especially during active play.







---

**SECTION II**

---

**THE GAME**

# CHAPTER 1

## FACILITIES AND EQUIPMENT

### Rule 1. Playing Area

The playing area includes the playing court and the free zone. It shall be rectangular and symmetrical. (see also 1.1; diagrams 1a, 1b)

#### 1.1 Dimensions (diagram 2)

##### USAV 1.1.1:

- a. The playing court is a rectangle measuring 18 x 9 m (59' x 29'6") surrounded by a free zone, which may be a minimum of 2 m (6'6 3/4"). It is not required that the free zone be symmetrical.
- b. For developmental purposes, the size of the playing court for 10 years & Under may be reduced to 16m X 9m (52' 6" X 29' 6").
- c. For developmental purposes, the size of the playing court for 8/9 years & Under may be reduced to 14m X 9m (46' X 29' 6").
- d. The free playing space is the space above the playing area which is free from any obstructions. For USA Volleyball nationally sanctioned competition and recommended for all other competitions, 7 m (23') is the minimum free playing space (ceiling height).

#### 1.2 Playing Surface

- 1.2.1: The surface must be flat, horizontal and uniform. It must not present any danger of injury to the players. It is forbidden to play on rough or slippery surfaces.

##### USAV 1.2.1:

- a. Players may mop the floor provided the 1st referee does not judge the action to be a delay.
- b. For nationally sanctioned competition, USA Volleyball must approve the surface.

USAV 1.2.2: It is recommended when using a portable playing surface that the color of the playing court be contrasting to that of the free zone.

- 1.2.3: On outdoor courts a slope of 5 mm per meter is allowed for drainage. Court lines made of solid materials are forbidden. (see also 1.3)

### 1.3 Lines On The Court (diagram 2)

**USAV 1.3.1:** All lines 5 cm (2") wide. Lines must contrast with the color of the floor. (see also 1.2.2)

#### 1.3.2: Boundary lines

Two sidelines and two end lines mark the playing court. Both sidelines and end lines are drawn inside the dimensions of the playing court. (see also 1.1)

#### 1.3.3: Center line

The axis of the center line divides the playing court into two equal courts measuring 9 x 9 m (29'6" x 29'6") each; however, the entire width of the line is considered to belong to both courts equally. This line extends beneath the net from sideline to sideline. (see also diagram 2)

#### **USAV 1.3.4:** Attack line

On each court, an attack line, whose rear edge is drawn 3 m (9'10") back from the axis of the center line, marks the front zone. (see also 1.3.3, 1.4.1)

For USA Volleyball nationally sanctioned competitions, the attack line are extended by the addition of broken lines from the sidelines, with five 15 cm (6") short lines 5 cm (2") wide, drawn 20 cm (8") from each other to a total length of 1.75 m (70"). These extensions are optional for all other events. (see also diagram 2)

### 1.4 Zones and Areas (diagrams 1b & 2)

#### 1.4.1: Front Zone

On each court the front zone is limited by the axis of the center line and the rear edge of the attack line. (see also 1.3.3, 1.3.4, 19.3.1.4, 23.3.2.3e; diagram 2)

The front zone is considered to extend beyond the sidelines to the end of the free zone. (see also 1.1, 1.3.2)

#### 1.4.2: Service Zone

The service zone is a 9 m (29'6") wide area behind each end line. It is laterally limited by two short lines, each 15 cm (6") long, drawn 20 cm (8") behind the end line as an extension of the sidelines. Both short lines are included in the width of the service zone. (see also 1.3.2, 12; diagram 1b)

**USAV 1.4.2:** In depth, the service zone extends to the end of the free zone and shall have a minimum depth of 2m (6' 6 3/4"). If this zone is less than 2m, a line shall be marked on the court to provide the minimum depth. After the service, the line is ignored and becomes part of the court. (see also 1.1)

1.4.3: Substitution Zone

The substitution zone is limited by the extension of both attack lines up to the scorer's table. (see also 1.3.4, 15.10.1; diagram 1b)

1.4.4: Libero Replacement Zone

The Libero Replacement Zone is part of the free zone on the side of the team benches, limited by the extension of the attack line up to the end line. (see also 19.3.2.7; diagram 1b)

**USAV 1.4.5:** Warm-up area

The warm-up area is outside the free zone at the end of each bench or bench area, and not nearer the court than the front of the team bench. Substitutes must not interfere with play or the officials' duties. (see also 24.2.5; diagrams 1a, 1b)

1.5 Temperature

The minimum temperature shall not be below 10° C (50° F).

1.6 Lighting

**USAV 1.6:**

For nationally sanctioned USA Volleyball competition, the lighting on the playing area should be 300 lux (27.9 foot candles) measured at 1 m (39") above the playing surface.

**Rule 2. Net and Posts (Diagram 3)**

2.1 Height Of The Net

**USAV 2.1.1:** Placed vertically over the center line there is a net whose top is set at the height of 2.43 m (7'11 5/8") for men and 2.24 m (7'4 1/8") for women. (see also 1.3.3, 2.1.2)

For specific age groups, the height of the net may vary as follows:

Age Groups	Female/Reverse Co-Ed	Male/Co-Ed
70 years and above	2.19 m (7'2 1/8")	2.29 m (7'6")
55 years and above	2.19 m (7'2 1/8")	2.38 m (7'9 5/8")
45 years and above	2.19 m (7'2 1/8")	2.43 m (7'11 5/8")
15/18 years and under	2.24 m (7'4 1/8")	2.43 m (7'11 5/8")
13/14 years and under	2.24 m (7'4 1/8")	2.24 m (7'4 1/8")
11/12 years and under	2.13 m (7'0")	2.13 m (7'0")
10 years and under	1.98 m (6'6")	2.13 m (7'0")

2.1.2: Its height is measured from the center of the playing court. The net height (over the two sidelines) must be exactly the same and must not exceed the official height by more than 2 cm (3/4"). (see also 1.1, 1.3.2, 2.1.1)

## 2.2 Structure

The net is 1 m (39") wide and 9.50 to 10 m (31'6"-33') long (with 25 to 50 cm [10"-19 1/2"] on each side of the side bands), made of 10 cm (4") square black mesh. (see also diagram 3)

At its top a horizontal band, 7 cm (2 3/4") wide, made of two-fold white canvas, is sewn along its full length. Each extreme end of the band has a hole, through which passes a cord, fastening the band to the posts for keeping its top taut.

Within the band, a flexible cable fastens the net to the posts and keeps its top taut.

At the bottom of the net there is another horizontal band, 5 cm (2") wide, similar to the top band, through which is threaded a rope. This rope fastens the net to the posts and keeps its lower part taut.

### **USAV 2.2:**

For USA Volleyball competition, the horizontal band described above may be 5 to 7 cm (2 to 2 3/4") wide, made of two-fold white canvas, and sewn along the full length of the net.

## 2.3 Side Bands (diagram 3)

### **USAV 2.3:**

The side bands are optional. When used:

Two white bands are fastened vertically to the net and placed directly above each sideline.

They are 5cm (2") wide and 1m (39") long and are considered as part of the net. (see also 1.3.2)

### **2.4 Antennae**

An antenna is a flexible rod, 1.80 m (5'11") long and 10 mm (3/8") in diameter, made of fiberglass or similar material.

An antenna is fastened at the outer edge of each side band. The antennae are placed on opposite sides of the net. (see 2.3, diagram 3)

The top 80 cm (32") of each antenna extends above the net and is marked with 10 cm (4") stripes of contrasting color, preferably red and white.

The antennae are considered as part of the net and laterally delimit the crossing space. (see 10.1.1, diagrams 3, 5a, 5b)

### **2.5 Posts**

#### **USAV 2.5:**

In addition to the systems described below, ceiling mounted net systems are allowed.

- 2.5.1: The posts supporting the net are placed at a distance of 0.50-1.00 m (20"-39") outside the sidelines. They are 2.55 m (8'4") high and preferably adjustable. (see diagram 3)
- 2.5.2: The posts are rounded and smooth, fixed to the ground without wires. There shall be no dangerous or obstructing devices.

### **2.6 Additional Equipment**

#### **USAV 2.6**

- a. If the posts are secured by barrels or other supporting apparatus, there must be some means of clearly identifying the barrels or supporting apparatus. All other dangerous or obstructing devices must be eliminated. Metal cables, tensioning devices and other exposed wires may need to be covered if the referees determine these items may cause injury to players.

- b. All wires that support posts from the floor will be eliminated, or if that is not possible, then all exposed wires must be padded with at least 1.25 cm (1/2") thick, resilient, shock-absorbing material throughout the entire length. The padding must be clearly recognizable.
- c. Posts shall be padded to a minimum height of 1.7 m (5'6") with at least 1.25 cm (1/2") thick, resilient, shock-absorbing material throughout the entire length. The padding must be clearly recognizable.
- d. Basic equipment includes a referee stand, which should be adjustable to allow the referee's eye position to be approximately 50 cm (19") above the top of the net. It should be constructed so that it presents the least potential hazard for participants. Step ladders, jump boxes and other devices not specifically designed as referee stands shall not be used. If an appropriate referee stand cannot be provided, the 1st referee performs his/her functions from the floor.
- e. The front and sides of the referee's stand must be padded in the same manner as the posts to a height of 1.7 m (5'6").
- f. The scoreboard must be divided into two separate parts with numbers that provide the score for each team. The score displayed on the scoreboard is not official and may not be used as a basis for protest.

## **Rule 3. Balls**

### **3.1 Standards**

The ball shall be spherical, made of a flexible leather or synthetic leather case with a bladder inside, made of rubber or a similar material.

Its color may be a uniform light color or a combination of colors. Synthetic leather material and color combinations of balls used in international official competitions should comply with FIVB standards.

Its circumference is 65-67 cm (25.6" to 26.4") and its weight is 260-280 g (9 to 10 oz).

Its inside pressure shall be 0.30 to 0.325 kg/cm<sup>2</sup> (4.26 to 4.61 psi) (294.3 to 318.82 mbar or hPa).

### **USAV 3.1:**

12 & Under competition at the USA Volleyball Junior National Championships will be conducted using a ball with the same circumference and inside pressure as listed in Rule 3.1, but with a weight of 198 to 227 g (7 to 8 oz).

### **3.2 Uniformity Of Balls**

All balls used in a match must have the same standards regarding circumference, weight, pressure, type, color, etc. (see also 3.1)

#### **USAV 3.2**

For nationally sanctioned USA Volleyball competitions, USA Volleyball must approve the game balls.

### **3.3 Ball Retrieval System**

#### **USAV 3.3**

For nationally sanctioned USA Volleyball competitions, a three-ball system is recommended.



## CHAPTER 2

### PARTICIPANTS

#### Rule 4. Teams

##### 4.1 Team Composition

###### USAV 4.1.1:

- a. Players are the team members on the team court. Substitutes are team members in uniform who are not in the starting line-up of a set.
  - b. A team may consist of a maximum of 15 players and five coaches/team personnel, unless modified by the Specific Competition Regulations. An American Sign Language interpreter may be included among the coaching staff or team personnel; see ASL Interpreter Guidelines.
  - c. A complete junior team consists of a minimum of six players and a USAV certified juniors' coach.
- 4.1.2: One of the players is the team captain, who shall be indicated on the score sheet. (see also 5.1)

###### USAV 4.1.3:

- a. Unless modified by specific competition regulations, at least 10 minutes before the start of each match, including tournament play, each team shall submit a roster listing the names and uniform numbers of players eligible to participate in the match. Only the players listed on the team roster may enter the court and play in a match. The coach or team captain must sign the roster. A roster may be changed at any time during the match, but only to correct a uniform number. However, if the coach or game captain requests such a number change, that team will be charged with a penalty point. A roster may not be changed to add a player at any time after having been signed by the coach or team captain. (see also USAV 4.1.1, USAV 5.1.1, 5.2.2, USAV 5.2.2)
- b. The coach and captain do not need to sign the score sheet before the match except for the Open Division of the USA Volleyball Open National Championships.

## 4.2 Location of the Team

4.2.1: The players not in play should either sit on their team bench or be in their warm-up area. The coach and other team members sit on the bench but may temporarily leave it. (see also USAV 1.4.5, 5.2.3, 7.3.3)

The benches for the teams are located beside the scorer's table, outside the free zone. (see diagrams 1a, 1b)

**USAV 4.2.1:** In conjunction with Rule 4.2.1 above, any team member may occupy any available seat on their team's bench, including the first chair reserved for the coach.

4.2.2: Only the team composition members are permitted to enter the playing area, to sit on the bench during the match and to participate in the official warm-up session. (see also 4.1.1, USAV 7.2)

4.2.3: Players not in play may warm up without balls as follows:

4.2.3.1: during play: in the warm-up areas (see also 1.4.5, diagrams 1a, 1b);

4.2.3.2: during time-outs (and technical time-outs, USAV 15.4.3): in the free zone behind their court. (see also 1.3.3, 5.4)

**USAV 4.2.4:** During set intervals, players may warm up using balls on their court or within their own free zone. During the extended interval between sets 2 and 3 (if used), players may use their own court as well. (see also USAV 18.1)

## 4.3 Equipment

### **USAV 4.3:**

- a. A player's uniform consists of a jersey and shorts or athletic/sports pants. If undergarments, including but not limited to T-shirts, boxer shorts, tights, leotards, body suits, bicycle shorts, sports bras, etc., are worn in such a manner that they are exposed, they will be considered a part of the uniform. In that case, they must be similar and the same color for any team members (except the Libero) who wear such an undergarment. Socks, sport shoes, knee pads, and compression pads are not part of the uniform.
- b. The legality of a team's uniform(s) is not grounds for a protest by their opponent. The determination of a team's uniform legality is the responsibility of the match referee(s), head referee(s), and/or tournament staff.

**USAV 4.3.1:** The color and design for the jerseys and shorts or athletic/ sports pants must be uniform for the team (except for the Libero). (see also 4.1, USAV 19.2)

4.3.2: The shoes must be light and pliable with rubber or composite soles without heels.

**USAV 4.3.3:** The players' jerseys must be numbered in a permanent manner from 1 to 99 using Arabic numerals. Duplicate numbers are not allowed. (see also USAV 4.3.3.2)

**USAV 4.3.3.1:**

- a. Uniform numbers must be clearly visible and centered side to side on the front and back of the jersey. Numbers are recommended to be placed on the upper half of the jersey. Numbers may not extend below the player's waist and may not be tucked into the uniform bottom.
- b. Each jersey must use the same color and number height for all players, except the Libero's jersey, which may have different colored and sized numbers, provided it still meets the minimum criteria stated in USAV 4.3.3.2.
- c. The color and brightness of the numbers must contrast with the color and brightness of the jersey. Color combinations including but not limited to purple/black, dark green/black, navy/black, white/light yellow or navy/maroon are not distinctive enough to comply with the rules.
- d. The color of the number must clearly contrast with the color of the jersey irrespective of any border around the number.

**USAV 4.3.3.2:** The numbers must be a minimum of 10 cm (4") in height on the chest and a minimum of 15 cm (6") in height on the back. It is recommended that the numbers be a minimum of 15 cm (6") in height on the chest and a minimum of 20 cm (8") on the back. The stripe forming the numbers shall be a minimum of 2cm (3/4") in width.

**USAV 4.3.4:** It is recommended that the captain have a stripe on his/her jersey, 8cm X 2cm (3.15" X .78"), underlining the number on the chest. (see also 5.1)

4.3.5: It is forbidden to wear uniforms of a color different from that of the other players (except for the Liberos), and/or without official numbers. (see also 19.2)

**USAV 4.3.5:** For nationally sanctioned competition, uniforms must be identical except for sleeve length and the Libero players. An exception will also be made for a single manufacturer's logo or trademark on the outside of the jerseys or shorts, provided that the logo or trademark does not exceed 14.6 square cm (2 1/4 square inches). Sponsor logos are permitted provided they are identical on each uniform and do not obstruct the view of the uniform number.

#### 4.4 Change Of Equipment

The 1st referee may authorize one or more players:

- 4.4.1: to play barefoot;
- 4.4.2: to change wet or damaged uniforms between sets or after substitution, provided that the color, design and number of the new uniform(s) are the same (see also USAV 4.3, 15.5);
- 4.4.3: to play in training suits in cold weather, provided that they are of the same color and design for the whole team (except for the Liberos) and numbered according to Rule 4.3.3. (see also 4.1.1, USAV 19.2)

#### 4.5 Personal Equipment And Prohibited Items

**USAV 4.5.1:** It is prohibited to wear a cast, even if padded. Objects or equipment that may cause an injury or give an artificial advantage to the player must not be worn. A head covering made from cloth or soft, non-abrasive fabric may be worn; no waiver is required. Hats of any style are not permitted. A guard or brace, or headgear, are permitted; padding or a covering may be necessary. A prosthetic limb(s) is permitted; sharp edges may need to be wrapped or padded to ensure safety.

Jewelry may be worn provided its nature does not present a concern for safety, such as extremely long necklaces and/or necklaces with large medallions, or large hoop earrings.

When a player's equipment falls to the floor and creates a safety hazard, play is stopped, and a delay sanction may be assessed.

- 4.5.2: Players may wear glasses or lenses at their own risk.

**USAV 4.5.3:** Compression pads (padded injury protection devices) may be worn for protection or support. The color of the compression pads does not need to be the same for team members wearing this equipment, nor does the color need to match the predominant color(s) of the team uniform.

## **RULE 5. Team leaders**

Both the team captain and the coach are responsible for the conduct and discipline of their team members. (see also Rule 20)

The liberos can be either the team or game captain.

### **5.1 Captain**

**USAV 5.1.1: PRIOR TO THE MATCH**, the team captain represents his/her team at the coin toss. The captain does not sign the score sheet before or after the match except in the Open Division of the USA Volleyball Open National Championships. (see also 7.1, USAV 25.2.1.1)

**5.1.2: DURING THE MATCH** and while on the court, the team captain is the game captain. When the team captain is not on the court, the coach or the team captain must assign another player on the court to assume the role of game captain. This game captain maintains his/her responsibilities until he/she is substituted, or the team captain returns to play, or the set ends. (see also 15.2.1)

When the ball is out of play, only the game captain is authorized to speak to the referees:

**USAV 5.1.2.1:** to ask for an explanation on the application or interpretation of the Rules, and also to submit the requests or questions of his/her teammates. (see also USAV 5.2)

If an explanation of an application or interpretation of a rule is not satisfactory to the game captain, he/she must immediately indicate his/her disagreement and file an official protest prior to the authorization of the next service. If the disagreement with the referee's explanation involves the last point of the set, the official protest must occur within the first 60 seconds of the timed interval between sets. (The protest is ruled upon by the Protest Committee immediately, prior to the start of the next set.)

If the final point of the match is disputed, the protest must occur within the first 60 seconds after the final point of the match is scored. It is advisable to have an assigned Protest Committee to

rule upon a protest as soon as possible prior to the first service following the protest. Such action should preclude replaying the match from the point of protest if the protest is upheld.

Protests to be considered by the 1st referee (Protest or Tournament Committee) include: 1) misinterpretation of a playing rule, 2) failure of the 1st referee to apply the correct rule to a given situation, 3) failure to charge the correct penalty-sanction for a given fault, or 4) a scoring discrepancy.

Judgment decisions are not subject to protest. A protest related to a judgment decision may result in a penalty (red card) being assessed to the coach.

Protest facts recorded on the score sheet at the time of the protest include: 1) the score of the set; 2) players and their positions; 3) player and team substitutions; 4) team time-outs taken; 5) situation that resulted in the protest; and 6) signatures of the scorer, captains and 1st referee, indicating the facts are correct. (see also USAV 5.2, 23.2.4; Protest Procedures in Basic Match Procedures for Referees)

5.1.2.2: to ask authorization:

to change all or part of the equipment (see also 4.3, 4.4.2);

to verify the positions of the teams (see also 7.4, 7.6);

to check the floor, the net, the ball, etc. (see also 1.2, 2, 3);

**USAV 5.1.2.3:** to request time-outs and substitutions. (see also 5.2, 5.3, 15.3.1, 15.4.1, 15.5.2)

**USAV 5.1.3: AT THE END OF THE MATCH,** the team captain thanks the referees but does not sign the score sheet.

## 5.2 Coach

### **USAV 5.2**

For nationally sanctioned USA Volleyball competition, the coach may act in place of the game captain to perform the functions stated in USAV 5.1.2.1 and 5.1.2.2. The coach is not permitted to cross the court to speak with the 1st referee. The 1st referee may leave the stand to address a coach near the team bench, if necessary, when a certified professional 2nd referee is not assigned to the match.

5.2.1: Throughout the match, the coach conducts the play of his/her team from outside the playing court. He/she selects the starting line-ups, the substitutes, and takes time-outs. In these functions his/her contacting official is the 2nd referee. (see also 1.1, 7.3.2, 15.4.1, 15.5.2)

**USAV 5.2.2: PRIOR TO THE MATCH**, the coach records or checks the names and numbers of his/her players on the (score sheet) team roster. The coach does not sign the score sheet before the match except in the Open Division of the USA Volleyball Open National Championships.

5.2.3: **DURING THE MATCH**, the coach:

5.2.3.1: prior to each set, gives the 2nd referee or the scorer the line-up sheet(s) duly filled in and signed (see also USAV 7.3.2, 7.4, 7.6);

**USAV 5.2.3.2:** may sit anywhere on the team bench and may also stand or walk in the team bench area as described in USAV 5.2.3.4. (see also 4.2);

**USAV 5.2.3.3:** requests time-outs and substitutions (see also 15.4, 15.5), and is authorized to speak to the referees to verify the positions of the teams;

**USAV 5.2.3.4:** may give instructions to players on the court while standing or walking within the free zone in front of his/her team's bench from the extension of the attack line up to and including the warm-up area, without disturbing or delaying the match. The coach must not obstruct the view of the line judges (see also USAV 1.3.4, USAV 1.4.5; diagrams 1a, 1b, 2).

### 5.3 Assist

**USAV 5.3.1:** One assistant coach at a time may give instructions to players on the court while standing or walking within the free zone in front of his/her team's bench from the extension of the attack line up to and including the warm-up area, without disturbing or delaying the match. The coach must not obstruct the view of the line judges. (see also USAV 4.2.1)

5.3.2: Should the coach have to leave his/her team for any reason including sanction, but excluding entering the court as a player, an assistant coach may assume the coach's functions for the duration of the absence, once confirmed to the referee by the game captain. (see also 5.1.2, 5.2)

## CHAPTER 3

### PLAYING FORMAT

#### **Rule 6. To score a point, to win a set and the match**

##### **6.1 To Score A Point**

###### **6.1.1: Point**

A team scores a point:

- 6.1.1.1: by successfully landing the ball on the opponent's court (see also 8.3);
- 6.1.1.2: when the opponent team commits a fault (see also 6.1.2);
- 6.1.1.3: when the opponent team receives a penalty (see also 16.2.3, 21.3.1).

###### **6.1.2: Fault**

A team commits a fault by making a playing action contrary to the rules (or by violating them in some other way). The referees judge the faults and determine the consequences according to the Rules:

- 6.1.2.1: If two or more faults are committed successively, only the first one is counted.
- 6.1.2.2: If two or more faults are committed by opponents simultaneously, a DOUBLE FAULT is called and the rally is replayed. (see also diagram 11-Signal 23)

###### **6.1.3: Rally And Completed Rally**

A rally is the sequence of playing actions from the moment of the service hit by the server until the ball is out of play. A completed rally is the sequence of playing actions which results in the award of a point. (see also 8.1, 8.2, 12.2.2.1, 15.2.3, 15.11.1.3, 19.3.2.1, 19.3.2.9)

This includes:

- the award of a penalty (see also 21.3.1)
  - loss of service for service hit made after the time limit. (see also USAV 12.4.4)
- 6.1.3.1: If the serving team wins a rally, it scores a point and continues to serve.



6.1.3.2: If the receiving team wins a rally, it scores a point and it must serve next.

## 6.2 To Win a Set

A set (except the deciding 5th set) is won by the team which first scores 25 points with a minimum lead of two points. In the case of a 24-24 tie, play is continued until a two-point lead is achieved (26-24; 27-25; etc.). (see also 6.3.2; diagram 11-Signal 9)

## 6.3 To Win the Match

**USAV 6.3.1:** The match is won by the team that wins two sets out of three (or three sets out of five).

**USAV 6.3.2:** In the case of a 1-1 (or 2-2) tie, the deciding 3rd (or 5th) set is played to 15 points with a minimum lead of two points. (see also 6.2, 7.1; diagram 11-Signal 9). If teams will change courts in the deciding set, the court change occurs when the leading team has scored 8 points.

**USAV 6.3.3:** A playoff set is considered a match and only one set will be played. The match is won by the team that scores either 15 or 25 points (as specified in the tournament guidelines) with a two-point advantage. If teams will change courts, the court change occurs when the leading team has scored 8 or 13 points, respectively.

## 6.4 Default and Incomplete Team

6.4.1: If a team refuses to play after being summoned to do so, it is declared in default and forfeits the match with the result 0-3 for the match and 0-25 for each set. (see also 6.2, 6.3)

**USAV 6.4.1:** Matches that are two sets out of three will have a match result of 0-2 or 1-2 depending when the default occurs.

6.4.2: A team that, without justifiable reason, does not appear on the playing court on time is declared in default with the same result as in Rule 6.4.1.

**USAV 6.4.2:** If failure to adhere to Rule 6.4.2 is due to insufficient players on a team to begin a match, the team forfeits the first set at match time. After a team forfeits the first set of a match, an interval of up to 10 minutes shall be allowed for the team to produce sufficient players to play the next set. If the team is complete (per USAV 4.1.1c) prior to the expiration of this interval, the late team will be permitted use of the full court for a four-minute warm-up before play begins. If, after the 10-minute interval the team is not

complete, the second set shall be declared a forfeit. If the match consists of the best three out of five sets, an additional 10-minute interval shall be allowed before the match is declared a forfeit.

- 6.4.3: A team that is declared INCOMPLETE for the set or for the match, loses the set or the match. The opponent team is given the points, or the points and the sets, needed to win the set or the match. The incomplete team keeps its points and sets. (see also 6.2, 6.3, 7.3.1)

## **Rule 7. Structure Of Play**

### **7.1 The Toss**

Before the match, the 1st referee carries out a toss to decide upon the first service and the sides of the court in the first set. (see also 12.1.1)

If a deciding set is to be played, a new toss will be carried out. (see also USAV 6.3.2)

**USAV 7.1.1:** The toss is taken in the presence of the two team captains. Multiple team representatives may attend the captains' meeting with the team captain. The 1st referee will confirm which player will represent the team for the toss. (see also 5.1)

- 7.1.2: The winner of the toss chooses: **EITHER**

7.1.2.1: the right to serve or to receive the service, (see also 12.1.1)

OR

7.1.2.2: the side of the court.

The loser takes the remaining choice.

### **7.2 Official Warm-Up Session**

**USAV 7.2.1:** The teams will have 10 minutes during the official warm-up session. The warm-up session may be extended by the event organizer.

**USAV 7.2.2:** For adult competition, if both team captains agree, the teams will warm up together at the net for 10 minutes; otherwise, each team will have five minutes separately. For consecutive warm-ups, the team with the first service has the court first.

**USAV 7.2.3:** For junior competition, teams will have two minutes of shared court time (balls may not cross the net), and four minutes of individual court time, e.g., 2-4-4. The team with the first service has the court first.

- c. When one team has exclusive use of the court, the other team must either be at its team bench or out of the playing area, or may assist with ball retrieving. Warming up with balls at the team bench or in the spectator walkways is not permitted.

### 7.3 Team Starting Line-Up

- 7.3.1: There must always be six players per team in play. (see also 6.4.3)  
The team's starting line-up indicates the rotational order of the players on the court. This order must be maintained throughout the set. (see also 7.6)

**USAV 7.3.2:** At least two minutes before the end of the timed warm-up period and 30 seconds prior to the expiration of the interval between sets, a coach or game captain submits the team's starting line-up on a signed line-up sheet to the 2nd referee or scorer. (see also 5.2.3.1, 24.3.1, 25.2.1.2)

- 7.3.3: The players who are not in the starting line-up of a set are the substitutes for that set (except the Liberos). (see also 15.5)

**USAV 7.3.4:** Once the line-up sheet has been delivered to the 2nd referee or scorer, no change in line-up may be authorized without a regular substitution. (see also 15.2.2, 15.5; diagram 11-Signal 5)

#### EXCEPTIONS:

If a team submits a line-up sheet that lists a player's number as both a Libero and as a starting player, the coach or captain shall immediately decide whether that player will be a Libero or a starting player, as follows:

- a. If the duplicate number will be a Libero, the coach must correct the line-up but only in the starting position where the Libero's number was recorded. The team will not be charged a substitution.
  - b. If the duplicate number will be a starting player, another player may immediately be designated as Libero.
- 7.3.5: Discrepancies between players' position on court and on the line-up sheet are dealt with as follows (see also 24.3.1):
- 7.3.5.1: when such a discrepancy is discovered before the start of the set, players' positions must be rectified according to those on the line-up sheet—there will be no sanction;

**USAV 7.3.5.1:** when a discrepancy involves a non-existent uniform number, the line-up sheet is corrected for that position only; no sanction or substitution is charged.

7.3.5.2: when, before the start of the set, any player on court is found not to be registered on the line-up sheet of that set, this player must be changed to conform to the line-up sheet—there will be no sanction;

**USAV 7.3.5.3:** however, if the coach wishes to keep such non-recorded player(s) on the court, he/she has to request regular substitution(s), which will then be recorded on the score sheet. (see also 15.2.2; diagram 11-Signal 5)

- a. If a discrepancy between player positions and the line-up sheet is discovered after play has begun, and the team at fault is serving, all points scored during that term of service, as well as all time-outs taken by the opponent, and substitutions and delay sanctions charged to either team, are canceled. The players' positions are corrected. The opponent's points remain valid. Individual misconduct sanctions assessed to either team and time-outs taken by the team at fault, are not canceled. (see also USAV 12)
- b. If a discrepancy between player positions and the line-up sheet is discovered during the opponent's term of service, the player positions of the team at fault are corrected; no additional penalty or sanction is assessed. However, if the opponent lost the rally immediately before discovery of the positional fault, a loss of rally is awarded to the opponent, and they continue serving. (see also USAV 12)

7.3.5.4: Where a player is found to be on court but he/she is not registered on the team roster, the opponent's points remain valid, and in addition they gain a point and service. The team at fault will lose all points and/or sets (0:25, if necessary) gained from the moment the non-registered player entered the court, and will have to submit a revised line-up sheet and send a new registered player into the court, in the position of the non-registered player. (see also 6.1.2)

## 7.4 Positions (diagram 4)

At the moment the ball is hit by the server, each team must be positioned within its own court in the rotational order (except the server). (see also 7.6.1, 8.1, 12.4)

7.4.1: The positions of the players are numbered as follows:

7.4.1.1: The three players along the net are front-row players and occupy positions 4 (front-left), 3 (front-center) and 2 (front-right);

7.4.1.2: The other three are back-row players occupying positions 5 (back-left), 6 (back-center) and 1 (back-right).

7.4.2: Relative positions between players:

7.4.2.1: Each back-row player must be positioned further back from the center line than the corresponding front-row player;

7.4.2.2: The front-row players and the back-row players, respectively, must be positioned laterally in the order indicated in Rule 7.4.1.

**USAV 7.4.3:** Players' positions are judged according to the foot/feet last in contact with the floor at the moment the ball is contacted for service, as follows:

7.4.3.1: each front-row player must have at least a part of one foot closer to the center line than the feet of the corresponding back-row player;

7.4.3.2: each right- (left-) side player must have at least a part of one foot closer to the right (left) sideline than the closest foot of the center player in that row.

7.4.4: After the service hit, the players may move around and occupy any position on their court and the free zone.

## 7.5 Positional Fault (diagram 4)

**USAV 7.5.1:** The team commits a positional fault if any player is not in his/her correct position at the moment the ball is hit by the server. When a player is on court through illegal substitution, and play restarts, this is counted as a positional fault. (see also 7.3, 7.4, 15.9; diagram 11-Signal 13)

If the positional fault is discovered while the team at fault is serving, all points scored subsequent to the fault must be cancelled. In addition, all time-outs taken by the team not at fault, as well as substitutions and team sanctions charged to either team subsequent to the commission of the positional fault, must be cancelled. Individual misconduct sanctions assessed to either team and time-

outs taken by the team at fault, are not cancelled. If the points scored while the player was out of position cannot be determined or the opponents have served, then a loss of rally is the only penalty charged, and the players' positions are corrected. The opponents retain any points scored.

- 7.5.2: If the server commits a serving fault at the moment of the service hit, the server's fault is counted before a positional fault. (see also 12.4, 12.7.1)
- 7.5.3: If the service becomes faulty after the service hit, it is the positional fault that will be counted. (see also 12.7.2)
- 7.5.4: A positional fault leads to the following consequences:
  - 7.5.4.1: the team is sanctioned with a point and service to the opponent; see also 6.1.3)
  - 7.5.4.2: players' positions must be rectified. (see also 7.3, 7.4)

## 7.6 Rotation

- 7.6.1: The rotational order is determined by the team's starting lineup and controlled with the service order and players' positions throughout the set. (see also 7.3.1, 7.4.1, 12.2)
- 7.6.2: When the receiving team has gained the right to serve, its players rotate one position clockwise: the player in position 2 rotates to position 1 to serve, the player in position 1 rotates to position 6, etc. (see also 12.2.2.2)

## 7.7 Rotational Fault

**USAV 7.7.1:** A rotational fault is committed when the SERVICE is not made according to the rotational order, including a Libero serving in a second rotation position in the same set. It leads to the following consequences in order (see also 7.6.1, 12, USAV 12):

- 7.7.1.1 the scorer stops play by the buzzer (or by whistle or verbal notification to the 2nd referee, USAV 22.2.1.3); the opponent gains a point and next service (see also 6.1.3);

If the rotational fault is determined only after the completion of the rally which started with a rotational fault, only a single point is awarded to the opponent, regardless of the result of the rally played.

7.7.1.2: the rotational order of the faulty team must be rectified; (see also 7.6.1)

**USAV 7.7.2:** If the rotational fault is discovered while the team at fault is serving or before the opponent serves, all points scored subsequent to the fault must be cancelled. In addition, all time-outs taken by the team not at fault, as well as substitutions and team sanctions charged to either team subsequent to the commission of the rotational fault, must be cancelled. Individual misconduct sanctions assessed to either team, and time-outs taken by the team at fault, are not cancelled. If the points scored while the player was out of rotation cannot be determined or the opponents have served, then a point and service to the opponents is the only penalty charged. The opponents retain any points scored.

## CHAPTER 4

### PLAYING ACTIONS

#### Rule 8. States of play

##### 8.1 Ball In Play

The ball is in play from the moment of the hit of the service authorized by the 1st referee. (see also 12, 12.3)

##### 8.2 Ball Out Of Play

The ball is out of play at the moment of the fault which is whistled by one of the referees; in the absence of a fault, at the moment of the whistle.

#### USAV 8.2:

In the case of an inadvertent whistle, the rally is ended. The 1st referee must make a ruling that will not penalize either team.

##### 8.3 Ball “In”

The ball is “in” if at any moment of its contact with the floor, some part of the ball touches the court, including the boundary lines. (see also 1.1, 1.3.2; diagram 11-Signal 14, diagram 12-Signal 1)

##### 8.4 Ball “Out”

The ball is “out” when:

- 8.4.1: all parts of the ball which contact the floor are completely outside the boundary lines (see also 1.3.2; diagram 11-Signal 15; diagram 12-Signal 2);

USAV 8.4.2: it touches an object outside the court or a person out of play (see also diagram 11-Signal 15, diagram 12-Signal 4);

A ball, other than a served ball, shall remain in play if it contacts the ceiling or other overhead objects 4.6 m (15') or more above the playing area.

- a. If benches, bleachers, low-hanging baskets or other floor obstructions are less than 2 m (6'6 3/4") from the court and interfere with play of the ball, the ball becomes out of play and a replay may be directed at the 1st referee's discretion.



- b. The ball is out of play when:
    - i. Rule 10.1.2 is not in effect, and the ball makes contact with the ceiling or obstruction above the opponent's playing area.
    - ii. Rule 10.1.2 is in effect, and a ball that cannot be legally retrieved from the opponent's free zone contacts the ceiling or obstruction over the opponent's playing area.
    - iii. The ball contacts the ceiling or obstruction above the team's playing area and crosses the plane of the net into the opponent's court.
    - iv. The ball contacts the ceiling or any obstruction after the team's third hit.
  - c. A ball, other than a served ball, is out of play and a replay directed if it contacts overhead object(s) or the supports (e.g., basketball backboard) less than 4.6 m (15') above the playing area and would have remained playable if the object had not been present.
  - d. A ball is out of play if it contacts the ceiling or overhead objects, regardless of height, over non-playing areas.
  - e. A ball is out of play and a replay is directed if the ball comes to rest on an overhead object above the team's playing area and is still a playable ball.
  - f. If an official, media equipment or personnel or spectator interferes with a player's legal attempt to play the ball over the playing area, a replay shall be directed.
- 8.4.3: it touches the antennae, ropes, posts or the net itself outside the side bands (see also 2.3; diagrams 3, 5a, 11-Signal 15, 12-Signal 4);
- 8.4.4: it crosses the vertical plane of the net either partially or totally outside the crossing space, except in the case of Rule 10.1.2 (see also 2.3; diagrams 5a, 5b, 11-Signal 15, 12-Signal 4);
- 8.4.5: it crosses completely the lower space under the net. (see also 23.3.2.3f; diagrams 5a, 11-Signal 22)

## **RULE 9. Playing the ball**

Each team must play within its own playing area and space (except Rule 10.1.2). The ball may, however, be retrieved from beyond its own free zone and over the scoring table in its complete extension. (see also diagram 1b)

### **USAV 9:**

Each team must play within its own playing area and space (except Rule 10.1.2). The ball may be retrieved from beyond the free zone when the surface change is 1.25 cm (1/2") or less, the secondary surface is lower than the free zone and the area is free of obstructions. If obstructions or other safety concerns prohibit retrieval from beyond the free zone, the player retrieving a ball over a non-playing area must be in contact with the playing surface when contact with the ball is made.

Non-playing areas are defined as the: (1) walls, bleachers or other spectator seating areas; (2) team benches and any area behind the team benches; (3) area between the scorer's table and the team benches; (4) any other area outlined in the pre-match conference by the 1st referee. (see also 23.2.5)

- a. If nets or dividers are separating courts, only the player attempting to play the ball may move the net or divider to play the ball.
- b. When competition is scheduled or is occurring on an adjacent court(s), it is a fault for a player to enter the adjacent court(s) to play the ball or after playing the ball. The free zone, including the service zone on an adjacent court, is a playing area. Adjacent courts may not share the same service zone.

### **9.1 Team Hits**

A hit is any contact with the ball by a player in play.

The team is entitled to a maximum of three hits (in addition to blocking), for returning the ball. If more are used, the team commits the fault of "FOUR HITS." (see also 14.4.1)

#### **9.1.1: Consecutive Contacts**

A player may not hit the ball two times consecutively (except Rules 9.2.3, 14.2 and 14.4.2). (see also 9.2.3, 14.2, 14.4.2)

#### **9.1.2: Simultaneous Contacts**

Two or three players may touch the ball at the same moment.

**USAV 9.1.2.1:** When two or more teammates touch the ball simultaneously, it is counted as one hit. Any player may play the ball next if the simultaneous hit is not the third team hit. A collision of players does not constitute a fault.

9.1.2.2: When two opponents touch the ball simultaneously over the net and the ball remains in play, the team receiving the ball is entitled to another three hits. If such a ball goes “out,” it is the fault of the team on the opposite side.

9.1.2.3: If simultaneous hits by two opponents over the net lead to an extended contact with the ball, play continues.

### 9.1.3: Assisted Hit

Within the playing area, a player is not permitted to take support from a teammate or any structure/object in order to hit the ball.

However, a player who is about to commit a fault (touch the net or cross the center line, etc.) may be stopped or held back by a teammate.

## 9.2 Characteristics of the Hit

9.2.1: The ball may touch any part of the body.

9.2.2: The ball must not be caught and/or thrown. It can rebound in any direction. (see also 9.3.3; diagram 11-Signal 6)

9.2.3: The ball may touch various parts of the body, provided that the contacts take place simultaneously.

Exceptions:

9.2.3.1: at blocking, consecutive contacts may be made by one or more player(s), provided that the contacts occur during one action;

9.2.3.2: at the first hit of the team, the ball may contact various parts of the body consecutively, provided that the contacts occur during one action. (see also 14.1.1, 14.2)

## 9.3 Faults In Playing The Ball

9.3.1: **FOUR HITS:** a team hits the ball four times before returning it. (see also 9.1, diagram 11-Signal 18)

9.3.2: **ASSISTED HIT:** a player takes support from a teammate or any structure/object in order to hit the ball within the playing area. (see also 9.1.3)

- 9.3.3: CATCH: the ball is caught and/or thrown; it does not rebound from the hit. (see also 9.2.2, diagram 11-Signal 16)
- 9.3.4: DOUBLE CONTACT: a player hits the ball twice in succession or the ball contacts various parts of his/her body in succession. (see also 9.2.3; diagram 11-Signal 17)

## **RULE 10. Ball at the net**

### **10.1 Ball Crossing the Net**

10.1.1: The ball sent to the opponent's court must go over the net within the crossing space. The crossing space is the part of the vertical plane of the net limited as follows (see also 2.4, 10.2; diagram 5a):

10.1.1.1 below, by the top of the net (see also 2.2);

10.1.2: The ball that has crossed the net plane to the opponent's freeze zone, totally or partly through the external space, may be played back within the three team hits, provided that (see also 9.1; diagram 5b):

10.1.1.2: at the sides, by the antennae, and their imaginary extension (see also 2.4);

10.1.1.3: above, by the ceiling.

10.1.2.1: the opponent's court is not touched by the player (see also 11.2.2);

10.1.2.2: the ball, when played back, crosses the net plane again totally or partly through the external space on the same side of the court. The opponent team may not prevent such action. (see also 11.4.4; diagram 5b)

**USAV 10.1.2:** In addition to the above, a minimum of 2 m (6'6 3/4") clearance beyond the court equipment at both ends of the net is required.

10.1.3 The ball that is heading toward the opponent's court through the lower space is in play until the moment it has completely crossed the vertical plane of the net. (see also 23.3.2.3f; diagrams 5a, 11-Signal 22)

### **10.2 Ball Touching the Net**

While crossing the net, the ball may touch it. (see also 10.1.1)

### **10.3 Ball In the Net**

10.3.1: A ball driven into the net may be recovered within the limits of the three team hits. (see also 9.1)

10.3.2: If the ball rips the mesh of the net or tears it down, the rally is cancelled and replayed.

## **RULE 11. Player at the net**

### **11.1 Reaching Beyond The Net**

- 11.1.1: In blocking, a player may touch the ball beyond the net, provided that he/she does not interfere with the opponent's play before the latter's attack hit. (see also 14.1, 14.3)
- 11.1.2: After an attack hit, a player is permitted to pass his/her hand beyond the net, provided that the contact has been made within his/her own playing space.

### **11.2 Penetration Under the Net**

- 11.2.1: It is permitted to penetrate into the opponent's space under the net, provided that this does not interfere with the opponent's play.
- 11.2.2: Penetration into the opponent's court, beyond the center line:
  - 11.2.2.1: to touch the opponent's court with a foot (feet) is permitted, provided that some part of the penetrating foot (feet) remains either in contact with or directly above the center line (see also 1.3.3; Diagram 11-Signal 22);
  - USAV 11.2.2.2:** to touch the opponent's court with any part(s) of the body is permitted, provided some part of the body remains either in contact with or directly above the center line, and there is no interference with opponents. In addition, completely crossing the center line with the foot, feet, or hands, or encroachment with other body parts, must not present a safety hazard to opponents. (see also 1.3.3; Diagram 11-Signal 22)
- 11.2.3: A player may enter the opponent's court after the ball goes out of play. (see also 8.2)
- 11.2.4: Players may penetrate into the opponent's free zone provided that they do not interfere with the opponent's play.

### **11.3 Contact with the Net**

- 11.3.1: Contact with the net by a player between the antennae, during the action of playing the ball, is a fault. The action of playing the ball includes (among others) take-off, hit (or attempt) and landing safely, ready for a new action. (see also 11.4.4, 23.3.2.3c, 24.3.2.3; diagram 3)
- 11.3.2: Players may touch the post, ropes, or any other object outside the antennae, including the net itself, provided that it does not interfere with play. (see also diagram 3)

11.3.3: When the ball is driven into the net, causing it to touch an opponent, no fault is committed.

#### 11.4 Player's Faults at the Net

11.4.1: A player touches the ball or an opponent in the opponent's space before or during the opponent's attack hit. (see also 11.1.1; diagram 11-Signal 20)

11.4.2: A player interferes with the opponent's play while penetrating into the opponent's space under the net. (see also 11.2.1)

11.4.3: A player's foot (feet) penetrates completely into the opponent's court. (see also USAV 11.2.2.2; diagram 11-Signal 22))

11.4.4: A player interferes with play by, amongst others (see also diagram 11-Signal 19):

touching the net between the antennae or the antenna itself during his/her action of playing the ball (see also 11.3.1),

using the net between the antennae as a support or stabilizing aid, creating an unfair advantage over the opponent by touching the net,

making actions which hinder an opponent's legitimate attempt to play the ball,

catching/holding onto the net.

Any player close to the ball as it is played, and who is him/herself trying to play it, is considered in the action of playing the ball, even if no contact is made with it. However, touching the net outside the antenna is not to be considered a fault (except for Rule 9.1.3).

## **RULE 12. Service**

The service is the act of putting the ball into play, by the back-right player, placed in the service zone. (see also 1.4.2, 8.1, 12.4.1)

### **USAV 12**

A team's term of service continues until that team commits a fault or receives a misconduct or delay penalty. A serving player may be replaced by substitution or a Libero at any time. (see also USAV 19.3.1.3b)

#### **12.1 First Service in a Set**

- 12.1.1: The first service of the first set, as well as that of the deciding 5th set, is executed by the team determined by the toss. (see also 6.3.2, 7.1)
- 12.1.2: The other sets will be started with the service of the team that did not serve first in the previous set.

#### **12.2: Service Order**

- 12.2.1 The players must follow the service order recorded on the line-up sheet. (see also 7.3.1, 7.3.2)
- 12.2.2 After the first service in a set, the player to serve is determined as follows (see also 12.1):
  - 12.2.2.1 when the serving team wins the rally, the player (or his/her substitute) who served before, serves again (see also 6.1.3, 15.5);
  - 12.2.2.2 when the receiving team wins the rally, it gains the right to serve and rotates before actually serving. The player who moves from the front-right position to the back-right position will serve. (see also 6.1.3, 7.6.2)

#### **12.3 Authorization of the Service**

The 1st referee authorizes the service, after having checked that the two teams are ready to play and that the server is in possession of the ball. (see also diagram 11-Signal 1)

### **USAV 12.3**

In addition to the above, when playing on a portable playing surface, the server shall have at least part of both feet in contact with the playing surface before the 1st referee authorizes the service. After the 1st referee authorizes the service, if the server steps entirely off the playing surface with one or both feet, it is a service fault. (see also USAV 12.4.3; diagram 11-Signal 22)



## 12.4 Execution of the Service

12.4.1 The ball shall be hit with one hand or any part of the arm after being tossed or released from the hand(s). (see also diagram 11-Signal 10)

12.4.2 Only one toss or release of the ball is allowed. Dribbling or moving the ball in the hands is permitted.

**USAV 12.4.3:** The service hit must take place on the playing area.

At the moment of the service hit or take-off for a jump service, the server must not touch the court (the end line included) or the floor outside the service zone. (see also 1.4.2, 27.2.1.4; diagram 11-Signal 22, diagram 12-Signal 4)

After the hit, he/she may step or land outside the service zone, or inside the court.

**USAV 12.4.4:** The server must hit the ball within 8 seconds after the 1st referee whistles for service. (see also 12.3; diagram 11-Signal 11)

For 14-and-under age groups:

- a. Once the serving action is initiated, including an underhand serve, if the server tosses the ball and then catches it or allows it to fall to the floor, this is considered a service tossing error, including a ball that touches the server as it falls.
- b. After a service tossing error, the referee must authorize the service again (re-serve) and the server must execute it within the next 8 seconds.
- c. One service tossing error is permitted for each service.

**USAV 12.4.5:** A service executed before the referee's whistle is cancelled and repeated. (see also 12.3)

After the whistle for the service, requests for game interruption, i.e., time-out or substitution, or a request for a line-up check, may not be considered until after the ball has been served and the rally completed, including a re-serve. A re-serve is part of a single effort to serve, and no requests will be honored during a re-serve. A request for line-up check is permitted when the result of a rally is a replay.

## 12.5 Screening (diagram 6)

12.5.1: The players of the serving team must not prevent their opponent, through individual or collective screening, from seeing the service

hit and the flight path of the ball. Should either be visible to the receiving team, this is not a screen.

**USAV 12.5.2:** A player or group of players of the serving team make(s) a screen by waving arms, jumping or moving sideways, during the execution of the service, or by standing grouped, and in so doing hides both the service hit and the flight path of the ball until the ball reaches the vertical plane of the net. (see also diagram 11-Signal 12)

The factors to be weighed when judging whether a screen has occurred are: (a) the relative positions of the players on the serving team; (b) the path of the serve; (c) the speed of the serve; and (d) the trajectory of the serve. If the players of the serving team are positioned close to each other, and the serve passes over these players at a fast, low trajectory, the probability is greater that a screen has occurred. This probability is lower if: (a) the players of the serving team are not positioned close to each other or are attempting to prevent a screen (i.e., bending over); (b) the path of the serve is not over the players; (c) the speed of the serve is slow; or (d) the trajectory of the serve is high.

## 12.6 Faults Made During The Service

### 12.6.1: Serving faults.

The following faults lead to a change of service even if the opponent is out of position. (see also 12.2.2.2, 12.7.1) The server:

12.6.1.1: violates the service order (see also 12.2);

**USAV 12.6.1.2:** does not execute the service properly, including a service toss that touches an obstruction before the service contact. (see also 12.4)

### 12.6.2: Faults after the service hit.

After the ball has been correctly hit, the service becomes a fault (unless a player is out of position) if the ball: (see also 12.4, 12.7.2)

**USAV 12.6.2.1:** touches a player of the serving team, fails to cross the vertical plane of the net completely through the crossing space, or touches any overhead obstruction. (see also 8.4.4, 8.4.5, 10.1.1, diagram 11-Signal 19)

12.6.2.2: goes “out” (see also 8.4; diagram 11-Signal 15);

12.6.2.3: passes over a screen. (see also 12.5; diagram 11-Signal 12)

## 12.7 Serving Faults and Positional Faults

- 12.7.1: If the server makes a fault at the moment of the service hit (improper execution, wrong rotational order, etc.) and the opponent is out of position, it is the serving fault which is sanctioned. (see also 7.5.1, 7.5.2, 12.6.1)
- 12.7.2: Instead, if the execution of the service has been correct, but the service subsequently becomes faulty (goes out, goes over a screen, etc.), the positional fault has taken place first and is sanctioned. (see also 7.5.3, 12.6.2)

## **RULE 13. Attack Hit**

### 13.1 Characteristics of the Attack Hit

- 13.1.1: All actions which direct the ball toward the opponent, with the exception of service and block, are considered as attack hits. (see also 12, 14.1.1)
- 13.1.2: During an attack hit, tipping is permitted only if the ball is cleanly hit, and not caught or thrown. (see also 9.2.2)
- 13.1.3: An attack hit is completed at the moment the ball completely crosses the vertical plane of the net or is touched by an opponent.

### 13.2 Restrictions of the Attack Hit

- 13.2.1: A front-row player may complete an attack hit at any height, provided that the contact with the ball has been made within the player's own playing space (except Rules 13.2.4 and 13.3.6). (see also 7.4.1.1)
- 13.2.2: A back-row player may complete an attack hit at any height from behind the front zone (see also 1.4.1, 7.4.1.2, 19.3.1.2; diagram 8)
- 13.2.2.1: at his/her take-off, the player's foot (feet) must neither have touched nor crossed over the attack line (see also 1.3.4);
- 13.2.2.2: after his/her hit, the player may land within the front zone.
- 13.2.3: A back-row player may also complete an attack hit from the front zone, if at the moment of the contact a part of the ball is lower than the top of the net.
- 13.2.4: No player is permitted to complete an attack hit on the OPPONENT'S service, when the ball is in the front zone and entirely higher than the top of the net.

### 13.3 Faults of the Attack Hit

- 13.3.1: A player hits the ball within the playing space of the opposing team. (see also diagram 11-Signal 20)
- 13.3.2: A player hits the ball “out.” (see also 8.4; diagram 11-Signal 15)
- 13.3.3: A back-row player completes an attack hit from the front zone, if at the moment of the hit the ball is entirely higher than the top of the net. (see also 1.4.1, 7.4.1.2; diagram 11-Signal 21)
- 13.3.4: A player completes an attack hit on the opponent’s service, when the ball is in the front zone and entirely higher than the top of the net. (see also 1.4.1, 13.2.4; diagram 11-Signal 21)
- 13.3.5: A Libero completes an attack hit if at the moment of the hit the ball is entirely higher than the top of the net. (see also 19.3.1.2, 23.3.2.3d; diagram 11-Signal 21)
- 13.3.6: A player completes an attack hit from higher than the top of the net when the ball is coming from an overhand finger pass by a Libero in his/her front zone. (see also 19.3.1.4, 23.3.2.3e; diagram 11-Signal 21)

**USAV 13.3.7:** If an attack-hit fault occurs simultaneously with a blocking fault by the opponents, a double fault is committed, and the rally is replayed. (see also 22.2.3.4)

## RULE 14. Block

### 14.1 Blocking

- 14.1.1: Blocking is the action of players close to the net to intercept the ball coming from the opponent by reaching higher than the top of the net, regardless of the height of the ball contact. Only front-row players are permitted to complete a block, but at the moment of the contact with the ball, a part of the body must be higher than the top of the net. (see also 7.4.1.1)
- 14.1.2: Block Attempt  
A block attempt is the action of blocking without touching the ball.
- 14.1.3: Completed Block  
A block is completed whenever the ball is touched by a blocker. (see diagram 7)

#### 14.1.4: Collective Block

A collective block is executed by two or three players close to each other and is completed when one of them touches the ball.

### 14.2 Block Contact

Consecutive (quick and continuous) contacts with the ball may occur by one or more blockers, provided that the contacts are made during one action. (see also 9.1.1, 9.2.3)

### 14.3 Blocking Within the Opponent's Space

In blocking, the player may place his/her hands and arms beyond the net, provided that this action does not interfere with the opponent's play. Thus, it is not permitted to touch the ball beyond the net **before** an opponent has executed an attack hit. (see also 13.1.1; diagram 11-Signal 20)

#### **USAV 14.3:**

Blocking the ball beyond the net above the opponent's team area shall be permitted, provided:

- a. the block is made after the opponents have hit the ball in such a manner that the ball would, in the 1st referee's judgment, clearly cross the net if not touched by a player, and no member of the attacking team is in a position to make a play on the ball.
- b. the ball is falling near the net, and no member of the attacking team could, in the 1st referee's judgment, make a play on the ball.

### 14.4 Block and Team Hits

14.4.1: A block contact is not counted as a team hit. Consequently, after a block contact, a team is entitled to three hits to return the ball. (see also 9.1)

14.4.2: The first hit after the block may be executed by any player, including the one who has touched the ball during the block.

### 14.5 Blocking the Service

To block an opponent's service is forbidden. (see also 12; diagram 11-Signal 12)

### 14.6 Blocking Faults

14.6.1: The blocker touches the ball in the OPPONENT'S space **before** the opponent's attack hit. (see also 14.3; diagram 11-Signal 20)

- 14.6.2: A back-row player or a Libero completes a block or participates in a completed block. (see also 14.1, 14.5, 19.3.1.3; diagram 11-Signal 12)
- 14.6.3: Blocking the opponent's service. (see also 14.5; diagram 11-Signal 12)
- 14.6.4: The ball is sent "out" off the block. (see also 8.4)
- 14.6.5: Blocking the ball in the opponent's space from outside the antenna.
- 14.6.6: A Libero attempts an individual or collective block. (see also 14.1.1, 19.3.1.3; diagram 11-Signal 12))

**USAV 14.6.7:** If a blocking fault is committed simultaneously with an attack-hit fault by the opponent, a double fault is committed, and the rally shall be replayed. (see also 22.2.3.4)

**USAV 14.6.8:** A block is the interception of a ball coming from the opponent. During the execution of the second or third team hit, it is a double contact fault if a player has successive contacts while using a blocking action to direct a ball toward the opponent. (see also 14.1.1, 19.3.1.3)



## CHAPTER 5

### INTERRUPTIONS, DELAYS AND INTERVALS

#### **RULE 15. Interruptions**

An interruption is the time between one completed rally and the 1st referee's whistle for the next service. (see also 6.1.3, 8.1, 8.2, 15.4, 15.5, 24.2.6)

The only regular game interruptions are TIME-OUTS and SUBSTITUTIONS.

#### **USAV 15:**

After the 1st referee whistles to authorize the service, a request for a regular game interruption or a request for a line-up check will not be honored. (see also 6.1.3, USAV 12.4.5, 15.11.1.1)

#### **15.1 Number of Regular Game Interruptions**

##### **USAV 15.1:**

Each team may request a maximum of two time-outs and 12 substitution per set. (see also 6.2, 15.4, 15.5, USAV 15.6)

The number of substitutions may be reduced to six per set with one entry per player when necessitated by the competition format. (see also USAV 15.6)

#### **15.2 Sequence of Regular Game Interruptions**

- 15.2.1 Request for one or two time-outs, and one request for substitution by either team may follow one another, within the same interruption. (see also 15.4, 15.5)
- 15.2.2 However, a team is not authorized to make consecutive requests for substitution during the same interruption. Two or more players may be substituted at the same time within the same request. (see also 15.5, 15.11.1.3)
- 15.2.3 There must be a completed rally between two separate substitution requests by the same team. Exception: a forced substitution due to injury or expulsion/disqualification (15.5.2, 15.7, 15.8). (see also 6.1.3, 15.5)



### 15.3 Request for Regular Game Interruptions

**USAV 15.3.1:** Regular game interruptions may be requested by either the coach or the game captain, and only by them. (see also 5.1.2, USAV 5.2.3.3, 5.3.2, USAV 15.10.3.1)

**USAV 15.3.2:** Substitution before the start of a set is permitted and should be recorded as a regular substitution in that set. (see also 7.3.4)  
Time-outs before the start of a set are permitted. (see also 15.4)

### 15.4 Time-Outs

15.4.1 Time-out requests must be made by showing the corresponding hand signal, when the ball is out of play and before the whistle for service. All requested time-outs last for 30 seconds. (see also 6.1.3, 8.2, 12.3; diagram 11-Signal 4)

**USAV 15.4.2:** During time-outs, the players may remain on the court or go to the free zone near their team bench. Any member of the team listed on the roster may participate in the time-out. Coaches and non-playing team members may not enter the court. Referees may direct teams to move to the free zone near their team bench for administrative purposes. Teams may return to the court when permitted by the referees. (see also diagram 1a)

**USAV 15.4.3:** The use of media (technical) time-outs, and their duration, is at the discretion of the event organizer.

### 15.5 Substitution

15.5.1: A substitution is the act by which a player, other than the Libero or his/her replacement player, after being recorded by the scorer, enters the game to occupy the position of another player, who must leave the court at that moment. (see also 19.3.2.1; diagram 11-Signal 5)

15.5.2: When the substitution is enforced through injury to a player in play this may be accompanied by the coach (or game captain) showing the corresponding hand signal. (see also 5.1.2.3, 5.2.3.3, 6.1.3, 8.2, 12.3; diagram 11-Signal 5)

### 15.6 Limitation Of Substitutions

#### **USAV 15.6:**

- a. Twelve substitutions are the maximum permitted per team per set. Substitution of one or more players is permitted at the same time.

- b. A player in the starting line-up may leave the set and re-enter, but only in his/her previous position in the line-up (Exception 15.7).
- c. A substitute may enter a set in the position of a teammate in the starting line-up.
- d. Unlimited individual entries by a substitute within the team's allowable 12 substitutions are permitted. Each entry must be in the same position in the line-up.
- e. More than one substitute may enter the set in each position.
- f. When the competition format utilizes six substitutions per set, a player in the starting line-up may leave the game, but only once in a set, and re-enter, but only once in a set, and only to his/her previous position in the line-up. A substitute player may enter the game in place of a player in the starting line-up, but only once per set, and he/she can only be substituted by the same starting player.

## 15.7 Exceptional Substitution

### **USAV 15.7:**

A player (except the Libero) who cannot continue playing due to injury/illness, or expulsion/disqualification, should be substituted legally. If this is not possible, the team is entitled to make an EXCEPTIONAL substitution, beyond the limits of Rule 15.6. (see also USAV 15.6, 19.4.3, 21.3.2, 21.3.3)

An exceptional substitution means that any player who is not on the court at the time of the injury/illness/expulsion/disqualification, except a Libero's replacement player, may be substituted into the game for the injured/ill/expelled/disqualified player. The injured/ill/expelled/disqualified player substituted via exceptional substitution is not allowed to re-enter the match.

- a. An exceptional substitution is not counted as an individual entry or as part of the total team substitutions, but is recorded on the scoresheet.
- b. Priority for an exceptional substitution:
  - i. by the starter or a substitute who has played in the position of the injured player, or by any substitute who has not already participated in the set;
  - ii. by any substitute on the bench, regardless of position previously played;
  - iii. by the Libero.

## 15.8 Substitution for Expulsion or Disqualification

An EXPELLED or DISQUALIFIED player must be substituted immediately through a legal substitution. If this is not possible, the team has the right to do an exceptional substitution. If this is not possible, the team is declared INCOMPLETE. (see also 6.4.3, 7.3.1, 15.6, 15.7, 21.3.2, 21.3.3; diagram 11-Signal 5)

## 15.9 Illegal Substitution

**USAV 15.9.1:** A substitution is illegal when it exceeds the limitations indicated in USAV 15.6 (except in the case of USAV 15.7). The following substitutes are illegal:

- a. player not on the roster;
- b. player with illegal number or uniform;
- c. exceeds the number of total team substitutions;
- d. player replaced by exceptional substitution.

15.9.2 When a team has made an illegal substitution and play has been resumed, the following procedure shall apply, in sequence (see also 8.1, 15.6):

15.9.2.1 the team is penalized with a point and service to the opponent (see also 6.1.3);

15.9.2.2 the substitution must be rectified;

### **USAV 15.9.2.3:**

- a. if the team at fault is serving, all points scored while the illegal substitute was on the court are canceled.
- b. if the team at fault is receiving and discovery is after the opponents have served, all points previously scored by the team at fault shall be retained. The serving team will be awarded a point unless the error is discovered after the serving team has scored a point. In this case, no additional point is awarded.
- c. if it is not possible to determine when the error first occurred and the team at fault is serving, only the last point in that term of service will be removed; the opponent's points remain valid.

**USAV 15.9.2.4:** No substitution will be charged to the team or player(s), even if required to correct the wrong entry. In addition, any player or team substitutions charged at the time of the wrong entry shall be removed from the score sheet as though they had never occurred.

## 15.10 Substitution Procedure

15.10.1: Substitution must be carried out within the substitution zone. (see also 1.4.3; diagram 1b)

15.10.2 A substitution shall only last the time needed for recording the substitution on the score sheet and allowing entry and exit of the players. (see also 24.2.6, 25.2.2.3)

**USAV 15.10.3.1:** The actual request for substitution starts at the moment of the entrance of the substitute player(s) into the substitution zone, ready to play, during an interruption. A verbal request for substitution is not acknowledged by the referees. The substitute must enter the substitution zone for the request to be acknowledged, except when the substitution is for an injury or before the start of a set.

15.10.3.2: If the player is not ready, the substitution is not granted and the team is sanctioned for a delay. (see also 16.2; diagram 9)

15.10.3.3: The request for substitution is acknowledged and announced by the scorer or 2nd referee, by use of the buzzer or whistle respectively. The 2nd referee authorizes the substitution. (see also 24.2.6)

**USAV 15.10.4:** If a team intends to make simultaneously more than one substitution, all substitute players must approach the substitution zone at the same time to be considered in the same request. In this case, substitutions must be made in succession, one pair of players after another. If one is illegal, the legal one(s) is/are granted and the illegal is rejected and subject to a delay sanction. Any significant delay between substitutes entering the substitution zone results in the team's subsequent substitution request(s) being denied. (see also 1.4.3, 15.2.2)

## 15.11 Improper Requests

15.11.1: It is improper to request any regular game interruption (see also 15):

- 15.11.1.1: during a rally or at the moment of or after the whistle to serve (see also 12.3);
- 15.11.1.2: by a non-authorized team member (see also 5.1.2.3, 5.2.3.3);
- 15.11.1.3: for a second substitution by the same team during the same interruption (i.e., before the end of next completed rally), except in the case of injury/illness/expulsion/disqualification of a player in play (see also 15.2.2, 15.2.3, 15.8, 16.1, 25.2.2.6);
- 15.11.1.4: after having exhausted the authorized number of time-outs and substitutions. (see also USAV 15.1)

**USAV 15.11.2:** The first improper request by a team in the match that does not affect or delay the game shall be rejected, but it must be recorded on the score sheet without any other consequences. (see also 16.1, 25.2.2.6)

If a change in request is due to a referee's mind change, the request will be honored, and no sanction assessed.

- 15.11.3: Any further improper request in the match by the same team constitutes a delay. (see also 16.1.4; diagram 11-Signal 25)

**USAV 15.11.4:** A request for first or second time-out may be honored immediately subsequent to an improper request for substitution. A proper request for substitution may be honored immediately subsequent to an improper request for time-out.

## **RULE 16. Game delays**

### **16.1 Types of Delays**

An improper action of a team that defers resumption of the game is a delay and includes, among others:

- 16.1.1: delaying regular game interruptions (see also 15.10.2);
- 16.1.2: prolonging interruptions, after having been instructed to resume the game (see also 15);
- 16.1.3: requesting an illegal substitution (see also 15.9);
- 16.1.4: repeating an improper request (see also 15.11.3);
- 16.1.5: delaying the game by a team member.

## **USAV 16.1:**

If a request for an illegal substitution or excessive time-out is acknowledged (i.e., whistled) by the referees, a delay sanction shall result. No additional request for game interruption from that team may be made until the next completed rally. Any substitution request that is improper or causes a delay is denied.

### **16.2 Delay Sanctions (diagram 9)**

16.2.1: “Delay warning” and “delay penalty” are team sanctions.

16.2.1.1: Delay sanctions remain in force for the entire match. (see also 6.3)

16.2.1.2: All delay sanctions are recorded on the score sheet. (see also 25.2.2.6)

16.2.2: The first delay in the match by a team member is sanctioned with a “DELAY WARNING.” (see also diagram 11-Signal 25)

16.2.3: The second and subsequent delays of any type by any member of the same team in the same match constitute a fault and are sanctioned with a “DELAY PENALTY”: a point and service to the opponent. (see also 6.1.3; diagram 11-Signal 25)

16.2.4: Delay sanctions imposed before or between sets are applied in the following set. (see also 18.1)

## **RULE 17. Exceptional game interruptions**

### **17.1 Injury/Illness**

**USAV 17.1.1:** Should a serious accident occur while the ball is in play, the referee must stop the game immediately and permit medical assistance to enter the court. The rally is then replayed. If the injured player cannot continue playing within a reasonable amount of time, the player must be replaced by substitution, a legal Libero replacement (if the Libero is not on the court at the time of the injury), or the team must take a legal time-out. (see also Guidelines for Dealing with Blood, Concussion Guidelines)

- a. If the referees are informed that a substitute will replace the injured player, no time-out will be charged regardless of the time required to safely remove the player from the playing area.
- b. No substitution requests may be made by the injured player’s team until the injury situation is resolved.

**USAV 17.1.2:** If an injured player is unable to play and a legal or exceptional substitution cannot be made, the referee must grant a special time-out of up to three minutes. Play will be resumed as soon as the injured player is able to continue. (see also 15.6, 15.7, 24.2.8) In no case shall the special injury time-out exceed three minutes. After the special time-out, a team may request a legal time-out. If, after three minutes, or at the expiration of time-outs granted subsequent to the special time-out, the injured player cannot continue to play, the team is declared incomplete for the set.

No player may be granted more than one three-minute injury time-out during any match. If a player becomes injured to the extent that a second injury time-out would be required, the team is declared incomplete for the match. (see also 6.4.3, 7.3.1)

## 17.2 External Interference

If there is any external interference during the game, the play has to be stopped and the rally is replayed. (see also 6.1.3; diagram 11-Signal 23)

## 17.3 Prolonged Interruptions

17.3.1: If unforeseen circumstances interrupt the match, the 1st referee, the organizer and the Control Committee, if there is one, shall decide the measures to be taken to re-establish normal conditions. (see also 23.2.3)

17.3.2: Should one or several interruptions occur, not exceeding 4 hours in total:

17.3.2.1: if the match is resumed on the same playing court, the interrupted set shall continue normally with the same score, players (except expelled or disqualified ones) and positions. The sets already played will keep their scores (see also 7.3);

**USAV 17.3.2.2:** if the match is resumed on another playing court, the interrupted set shall continue normally with the same score, players (except expelled or disqualified ones), and positions. The sets already played will keep their scores. (see also 7.3, 21.4.1; diagram 9)

17.3.3: Should one or several interruptions occur, exceeding 4 hours in total, the whole match shall be replayed.

## **Rule 18. Intervals and Change Of Courts**

### **18.1 Intervals**

#### **USAV 18.1:**

An interval is the time between sets. All intervals last 3 minutes. (see also 4.2.4)

During this time, team line-ups are submitted and recorded on the score sheet. If teams will change courts between sets during the match, the change of courts takes place during the interval. (see also 7.3.2, 18.2, 25.2.1.2)

The interval between the second and the third set can be extended up to 10 minutes by the organizer.

### **18.2 Change Of Courts**

**USAV 18.2.1:** The default protocol is for each team to remain on their respective side of the court throughout the match, including the deciding set.

EXCEPTIONS:

**USAV 18.2.1.1:** The event organizer determines there is a clear disadvantage on only one side of the court.

**USAV 18.2.1.1.1:** In the case of a clear disadvantage, the decision to change courts will remain in effect for the duration of the match but may change for a subsequent match.

**USAV 18.2.1.2:** The event organizer may determine that a change of courts will take place between sets and during a deciding set for all matches.

NOTE: The decision to change or not change courts is not grounds for a protest.

**USAV 18.2.2:** If the teams will change courts during the deciding set in accordance with USAV 18.2.1.1 or USAV 18.2.1.2, the change of courts takes place when the leading team reaches 8 points. If the change is not made once the leading team reaches 8 points, it will take place as soon as the error is noticed. The score at the time the change is made remains the same. (see also 6.3.2, 7.4.1, 25.2.2.5)



## CHAPTER 6

### THE LIBERO PLAYER

#### Rule 19. The Libero Player

##### 19.1 Designation of the Libero

**USAV 19.1.1:** Each team has the right to designate from the list of players on the score sheet (roster) up to two specialized defensive players called Liberos. If the team chooses to designate two Liberos at the start of the match, they are designated as Liberos for the entire match. If the team chooses to designate only one Libero (or no Libero) at the start of the match, the team may choose to change the player designated as Libero for each set, including playing any set with no Libero, but may not designate a second Libero for any subsequent set in the match. (see also 5)

19.1.2 All Liberos must be recorded on the score sheet in the special lines reserved for this. (see also 5.2.2, 25.2.1.1, 26.2.1.1)

19.1.3 The Libero on court is the Acting Libero. If there is another Libero, he/she is the second Libero for the team. Only one Libero may be on court at any time.

##### 19.2 Equipment

#### **USAV 19.2 (see also 4.3):**

- a. The Libero must wear a jersey that clearly contrasts with, and has a different dominant color from, the jersey of their teammates.
- b. A jacket or bib can only be worn by the re-designated Libero. If a jacket or bib is worn by the re-designated Libero, the uniform number must still be visible.
- c. Numbers shall be a contrasting color to the uniform top and meet all other specifications in USAV 4.3.3.1. Color combinations including but not limited to purple/black, dark green/black, navy/maroon, and white/light yellow are not distinctive enough to comply with the rules.

NOTE: The color of the number must clearly contrast with the color of the jersey irrespective of any border around the number.

- d. When two Liberos are used, both Liberos can be in uniforms different from each other and from the rest of the team.

## 19.3 Actions Involving The Libero

### 19.3.1: The playing actions:

- 19.3.1.1: the Libero is allowed to replace any player in a back-row position (see also 7.4.1.2);
- 19.3.1.2: He/she is restricted to perform as a back-row player and is not allowed to complete an attack hit from anywhere (including playing court and free zone) if at the moment of the contact the ball is entirely higher than the top of the net (see also 13.2.2, 13.2.3, 13.3.5);

### **USAV 19.3.1.3:**

- a. The Libero may not block or attempt to block. (see also 14.6.2, 14.6.6; diagram 11-Signal 12)
  - b. In one position a Libero may serve after replacing the player in position 1. (see also 12.4.1, USAV 19.3.2.1c)
- 19.3.1.4 A player (teammate) may not complete an attack hit when the ball is entirely higher than the top of the net, if the ball is coming from an overhand finger pass by a Libero in his/her front zone. The ball may be freely attacked if the Libero makes the same action from outside his/her front zone. (see also 1.4.1, 13.3.6, 23.3.2.3d/e; diagram 1b)

### 19.3.2 Libero Replacements

**USAV 19.3.2.1:** Libero replacements are not counted as substitutions. They are unlimited but there must be a completed rally between two Libero replacements. (see also 6.1.3, 15.5)

#### EXCEPTIONS:

- a. A penalty causes the team to rotate and the Libero to move to position four;
- b. The Acting Libero becomes unable to play making the rally incomplete; or,
- c. In one rotation, a Libero can replace the player in position 1 and serve the next rally, even if he/she is already on the court in replacement of another player. In this situation, the Libero does not have to exit the court before replacing the player in position 1, and there does not need to be a completed rally between Libero replacements. (see also USAV 19.3.1.3a)

- 19.3.2.2 The regular replacement player may replace and be replaced by either Libero. The Acting Libero can only be replaced by the regular replacement player for that position or by the second Libero.
- 19.3.2.3: At the start of each set, the Libero cannot enter the court until the 2nd referee has checked the line-up and authorized a Libero replacement with a starting player. (see also 7.3.2, 12.1)
- 19.3.2.4: Other Libero replacements must only take place while the ball is out of play and before the whistle for service. (see also 8.2, 12.3)
- 19.3.2.5: A Libero replacement made after the whistle for service but before the service hit should not be rejected; however, at the end of the rally, the game captain must be informed that this is not a permitted procedure, and that repetition will be subject to delay sanctions. (see also 12.3, 12.4; diagram 9)
- 19.3.2.6: Subsequent late Libero replacements shall result in the play being interrupted immediately, and the imposition of a delay sanction. The team to serve next will be determined by the level of the delay sanction. (see also 16.2; diagram 9)
- 19.3.2.7: The Libero and the replacing player may only enter or leave the court through the Libero Replacement Zone. (see also 1.4.4; diagram 1b)
- 19.3.2.8: Libero replacements must be recorded on the Libero Control Sheet (if one is used) or on the electronic score sheet. (see also 26.2.2.1, 26.2.2.2)
- 19.3.2.9: An illegal Libero replacement can involve (amongst others): no completed rally between Libero replacements (see also 6.1.3); the Libero being replaced by a player other than the second Libero or the regular replacement player. (see also 15.9)

An illegal Libero replacement should be considered in the same way as an illegal substitution (see also 15.9; diagram 9):

i.e. should the illegal Libero replacement be noticed before the start of the next rally, then this is corrected by the referees, and the team is sanctioned for delay; should the illegal Libero replacement be noticed after the service hit, the consequences are the same as for an illegal substitution.

## 19.4 Re-Designation Of A New Libero

19.4.1: The Libero becomes unable to play if injured, ill, expelled or disqualified. (see also 21.3.2, 21.3.3; diagram 9)

The Libero can be declared unable to play for any reason by the coach or, in the absence of a coach, by the game captain. (see also 5.1.2, 5.2.1)

### 19.4.2 Team with one Libero

19.4.2.1: When only one Libero is available for a team according to Rule 19.4.1, or the team has only one registered, and this Libero becomes or is declared unable to play, the coach (or game captain if no coach is present) may re-designate as Libero for the remainder of the set any other player (replacement player excepted) not on the court at the moment of the re-designation. (see also 19.4, 19.4.1)

19.4.2.2: If the Acting Libero becomes unable to play, he/she may be replaced by the regular replacement player or immediately and directly to court by a re-designated Libero. However, a Libero who is the subject of a re-designation may not play for the remainder of the match. If the Libero is not on court when declared unable to play, he/she may also be the subject of a re-designation. The Libero declared unable to play may not play for the remainder of the match.

19.4.2.3: The coach, or game captain if no coach is present, contacts the 2nd referee informing him/her about the re-designation. (see also 5.1.2, 5.2.1)

19.4.2.4: Should a re-designated Libero become or be declared unable to play, further re-designations are permitted. (see also 19.4.1)

19.4.2.5: If the coach requests the team captain to be re-designated as the new Libero, this will be permitted. (see also 5.1.2, 19.4.1)

19.4.2.6: In the case of a re-designated Libero, the number of the player re-designated as Libero must be recorded on the score sheet remarks section and on the Libero control sheet (or electronic score sheet if one is used). (see also 25.2.2.7, 26.2.2.1)

### 19.4.3: Team with two Liberos

19.4.3.1: Where a team has registered on the score sheet two Liberos, but one becomes unable to play the team has the right to play with only one Libero. (see also 4.1.1, 19.1.1)

No re-designation will be allowed, however, unless the remaining Libero is unable to continue playing for the match.

## 19.5 Summary

- 19.5.1: If the Libero is expelled or disqualified, he/she may be replaced immediately by the team's second Libero. Should the team have only one Libero, then it has the right to make a re-designation. (see also 19.4, 21.3.2, 21.3.3)

## CHAPTER 7

### PARTICIPANTS' CONDUCT

#### **RULE 20. Requirements of Conduct**

##### **20.1 Sportsmanlike Conduct**

20.1.1: Participants must know the "Official Volleyball Rules" and abide by them.

20.1.2: Participants must accept referees' decisions with sportsmanlike conduct, without disputing them.

In case of doubt, clarification may be requested only through the game captain. (see also USAV 5.1.2.1)

20.1.3: Participants must refrain from actions or attitudes aimed at influencing the decisions of the referees or covering up faults committed by their team.

##### **20.2 Fair Play**

20.2.1: Participants must behave respectfully and courteously in the spirit of FAIR PLAY, not only toward the referees, but also toward other officials, the opponent, teammates and spectators.

20.2.2: Communication between team members during the match is permitted.

#### **RULE 21. Misconduct and Its Sanctions**

##### **21.1 Minor Misconduct**

Minor misconduct offenses are not subject to sanctions. It is the 1st referee's duty to prevent the teams from approaching the sanctioning level. This is done in two stages (see also 5.1.2, 21.3):

Stage 1: by issuing a verbal warning through the game captain;

Stage 2: by use of a YELLOW CARD to the team member(s) concerned. This formal warning is not in itself a sanction but a symbol that the team member (and by extension, the team) has reached the sanctioning level for the match. It is recorded in the score sheet but has no immediate consequences. (see also diagram 11-Signal 6a)

## **USAV 21.1**

NOTE: Yellow card warnings are assessed to individuals but are in force for the entire team. This means each team may receive only one yellow card per match.

### **21.2 Misconduct Leading to Sanctions**

Incorrect conduct by a team member toward officials, opponents, teammates or spectators is classified in three categories according to the seriousness of the offense.

- 21.2.1: Rude conduct: action contrary to good manners or moral principles.
- 21.2.2: Offensive conduct: defamatory or insulting words or gestures or any action expressing contempt.
- 21.2.3: Aggression: actual physical attack or aggressive or threatening behavior.

### **21.3 Sanction Scale (diagram 9)**

According to the judgment of the 1st referee and depending on the seriousness of the offense, the sanctions to be applied and recorded on the score sheet are: Penalty, Expulsion or Disqualification. (see also 21.2, 25.2.2.6)

#### **21.3.1: Penalty (diagram 11-Signal 6b)**

The first rude conduct in the match by any team member is penalized with a point and service to the opponent. (see also 4.1.1, 21.2.1)

#### **21.3.2: Expulsion (diagram 11-Signal 7)**

**USAV 21.3.2.1:** A player or substitute who is sanctioned by expulsion shall not play for the rest of the set and must remain seated on the team's bench for the remainder of that set. If on court, the player must be immediately substituted legally/exceptionally. Any other team member sanctioned by expulsion must leave the playing area, bench, and warm-up area for the remainder of the set and loses his/her right to intervene in the set. (see also 4.1.1, 5.2.1, 5.3.2)

- 21.3.2.2: The first offensive conduct by a team member is sanctioned by expulsion with no other consequences. (see also 4.1.1, 21.2.2)

21.3.2.3: The second rude conduct in the same match by the same team member is sanctioned by expulsion with no other consequences. (see also 4.1.1, 21.2.1)

21.3.3 Disqualification (diagram 11-Signal 8)

**USAV 21.3.3.1:** A team member who is sanctioned by disqualification must be substituted legally/exceptionally and immediately if on court and must leave the Competition-Control Area for the rest of the match with no other consequences. For the purposes of a disqualification, the Competition Control Area described above includes, at a minimum, the playing area, bench, warm-up area and spectator area. (see also 4.1.1; diagram 1a)

21.3.3.2: The first physical attack or implied or threatened aggression is sanctioned by disqualification with no other consequences. (see also 21.2.3)

21.3.3.3: The second offensive conduct in the same match by the same team member is sanctioned by disqualification with no other consequences. (see also 4.1.1, 21.2.2)

21.3.3.4: The third rude conduct in the same match by the same team member is sanctioned by disqualification with no other consequences. (see also 4.1.1, 21.2.1)

## 21.4 Application of Misconduct Sanctions

21.4.1: All misconduct sanctions are individual sanctions, remain in force for the entire match and are recorded on the score sheet. (see also 21.3, 25.2.2.6)

21.4.2 The repetition of misconduct by the same team member in the same match is sanctioned progressively (the team member receives a heavier sanction for each successive offense). (see also 4.1.1, 21.2, 21.3; diagram 9)

21.4.3 Expulsion or disqualification due to offensive conduct or aggression does not require a previous sanction. (see also 21.2, 21.3)

## 21.5 Misconduct Before and Between Sets

Any misconduct occurring before or between sets is sanctioned according to Rule 21.3 and sanctions apply in the following set. (see also 18.1, 21.2, 21.3)



## 21.6 Summary of Misconduct and Cards Used

Warning: no sanction –

Stage 1: verbal warning

Stage 2: symbol Yellow card (see also 21.1; diagram 11-Signal 6a)

Penalty: sanction – symbol Red card (see also 21.3.1; diagram 11-Signal 6b)

Expulsion: sanction – symbol Red + Yellow cards jointly (see also 21.3.2; diagram 11-Signal 7)

Disqualification: sanction – symbol Red + Yellow card separately (see also 21.3.3; diagram 11-Signal 8)





---

**SECTION III**

---

**THE GAME  
OFFICIALS**

## CHAPTER 8

### REFEREES

#### RULE 22. Refereeing Corps and Procedures

##### 22.1 COMPOSITION

The refereeing corps for a match is composed of the following officials:

- the 1st referee (see also 23);
- the 2nd referee (see also 24);
- the scorer (see also 25);
- the assistant scorer (see also 26);
- two (four) line judges (see also 27).

Their location is shown in diagram 10.

##### 22.2 Procedures

22.2.1: Only the 1st and 2nd referees may blow a whistle during the match:

22.2.1.1: the 1st referee gives the signal for the service that begins the rally (see also 6.1.3, 12.3; diagram 11-Signal 1);

22.2.1.2: the 1st or 2nd referee signals the end of the rally, provided that they are sure that a fault has been committed and they have identified its nature.

**USAV 22.2.1.3:** The scorer may use an audible device, including a whistle, to notify the referees of a rotational fault.

22.2.2: They may blow the whistle when the ball is out of play to indicate that they authorize or reject a team request. (see also 5.1.2, 8.2)

22.2.3: Immediately after the referee's whistle to signal the completion of the rally, they have to indicate with the official hand signals (see also 28.1):

22.2.3.1: If the fault is whistled by the 1st referee, he/she will indicate in order:

- a. the team to serve (see also diagram 11-Signal 2);
- b. the nature of the fault;
- c. the player(s) at fault (if necessary).

**USAV 22.2.3.1:** The 2nd referee will repeat the 1st referee's hand signals.

22.2.3.2: If the fault is whistled by the 2nd referee, he/she will indicate:

- a. the nature of the fault;
- b. the player at fault (if necessary);
- c. the team to serve following the hand signal of the 1st referee.

In this case, the 1st referee does not show either the nature of the fault or the player at fault, but only the team to serve.

22.2.3.3: In the case of an attack hit fault or blocking fault by back-row or Libero players, both referees indicate according to 22.2.3.1 and 22.2.3.2 above. (see also 13.3.3, 13.3.5, 19.3.1.2; diagram 11-Signals 12 & 21)

22.2.3.4: In the case of a double fault (see diagram 11-Signal 23) both referees indicate in order:

- a. the nature of the fault;
- b. the players at fault (if necessary).

The team to serve next is then indicated by the 1st referee.

## **RULE 23. 1st Referee**

### **23.1 Location**

The 1st referee carries out his/her functions standing on a referee's stand located at one end of the net on the opposite side to the scorer. His/her view must be approximately 50 cm (19½") above the net. (see also diagrams 1a, 1b, 10)

### **23.2 Authority**

23.2.1: The 1st referee directs the match from the start until the end. He/she has authority over all members of the refereeing corps and the members of the teams. (see also 4.1.1, 6.3)

During the match his/her decisions are final. He/she is authorized to overrule the decisions of other members of the refereeing corps, if it is noticed that they are mistaken.

He/she may even replace a member of the refereeing corps who is not performing his/her functions properly.

23.2.2: He/she also controls the work of the ball retrievers, floor wipers and moppers. (see also 3.3)

- 23.2.3: He/she has the power to decide any matters involving the game, including those not provided for in the rules.
- 23.2.4: He/she shall not permit any discussion about his/her decisions. (see also 20.1.2)

However, at the request of the game captain, the 1st referee will give an explanation on the application or interpretation of the rules upon which he/she has based the decision.

If the game captain does not agree with this explanation and chooses to protest against such decision, he/she must immediately reserve the right to file a protest before the match resumes. The 1st referee must authorize this right of the game captain. (see USAV 5.1.2.1 for Protest Procedures)

- 23.2.5: The 1st referee is responsible for determining before and during the match whether the playing area equipment and the conditions meet playing requirements.

### 23.3 Responsibilities

23.3.: Prior to the match, the 1st referee:

- 23.3.1.1: inspects the conditions of the playing area, the balls and other equipment (see also Chapter 1);
- 23.3.1.2: performs the toss with the team captains (see also 7.1);
- 23.3.1.3: controls the teams' warming up. (see also 7.2)

23.3.2 During the match, he/she is authorized:

- 23.3.2.1: to issue warnings to the teams (see also 21.1);
- 23.3.2.2: to sanction misconduct and delays (see also 16.2, 21.2; diagram 9, diagram 11-Signals 6a, 6b, 7, 8, 25);
- 23.3.2.3: to decide upon:
- a. the faults of the server and of the positions of the serving team, including the screen (see also 7.5, 12.4, 12.5, 12.7.1, diagrams 4 & 6, diagram 11-Signals 12, 13, 22);
  - b. the faults in playing the ball (see also 9.3; diagram 11-Signals 16, 17, 18);
  - c. the faults above the net, and the faulty contact of the player with the net, primarily (but not exclusively) on the attacker's side (see also 11.3.1, 11.4.1, 11.4.4; diagram 11-Signals 19 & 20);

- d. the attack hit faults of the Libero and back-row players (see also 13.3.3, 13.3.5, 24.3.2.4; diagram 8 & diagram 11-Signal 21);
- e. the completed attack hits made by a player on a ball above net height coming from an overhand pass with fingers by the Libero in his/her front zone (see also 13.3.6, 24.3.2.4; diagram 11-Signal 21);
- f. the ball crossing completely the lower space under the net (see also 8.4.5, 24.3.2.7; diagram 5a, diagram 11-Signal 22);
- g. the completed block by back-row players or the attempted block by the Libero (see also 14.6.2, 14.6.6; diagram 11-Signal 12);
- h. the ball that crosses the net totally or partly outside of the crossing space to the opponent's court or contacts the antenna on his/her side of the playing court (see also diagram 11-Signal 15);
- i. the served ball and the third hit passing over or outside the antenna on his/her side of the court (see also diagram 11-Signal 15).

23.3.3: At the end of the match, he/she checks the score sheet and signs it. (see also 24.3.3, 25.2.3.3)

## **RULE 24. 2nd Referee**

### **24.1 Location**

The 2nd referee performs his/her functions standing outside the playing court near the post, on the opposite side of and facing the 1st referee. (see also diagrams 1a, 1b, 10)

### **24.2 Authority**

24.2.1: The 2nd referee is the assistant of the 1st referee, but has also his/her own range of jurisdiction. (see 24.3)

Should the 1st referee become unable to continue his/her work, the 2nd referee may replace him/her.

24.2.2: He/she may, without whistling, also signal faults outside his/her range of jurisdiction, but may not insist on them to the 1st referee.

24.2.3: He/she controls the work of the scorer(s). (see also 25.2, 26.2)

24.2.4: He/she supervises the team members on the team bench and reports their misconduct to the 1st referee. (see also 4.2.1)

24.2.5: He/she controls the players in the warm-up areas. (see also 4.2.3)

**USAV 24.2.6:** He/she authorizes the regular game interruptions, controls their duration, including Technical Time-outs, and rejects improper requests. (see also 15, 15.11, 25.2.2.3)

**USAV 24.2.7:**

- a. He/she controls the number of time-outs and substitutions used by each team and reports the second time-out and substitutions 9, 10, 11, and 12 to the appropriate coach or game captain. (see also 15.1, 25.2.2.3)
  - b. He/she notifies the 1st referee of a team's second time-out and 12th substitution.
  - c. Failure to report team substitutions or time-outs to the coach or captain is not grounds for a protest.
  - d. During the match, the coach or captain may request verification of the number of team substitutions or time-outs. If incorrect information is provided by the 2nd referee and the team acts directly upon this misinformation resulting in an illegal substitution (per USAV 15.9.1) or an excessive time-out, the referee's error will be corrected with no penalty or sanction assessed to the team. **If an illegal (excessive) substitution does not result, the substitution may still be withdrawn prior to the next serve without sanction or penalty.**
  - e. When a referee incorrectly informs a coach or captain that the team has used all time-outs or team substitutions, but later discovers the information is inaccurate and corrects it, the team has no basis for a protest since teams also have a responsibility to maintain records of their team substitutions and time-outs.
  - f. When a team acts upon misinformation but the action does not result in an excessive substitution or time-out, the request is considered legal and is not grounds for the team to change or withdraw the request. A delay sanction is assessed if the team withdraws a legal request that has been acknowledged (whistled) by a referee.
- 24.2.8: In the case of an injury of a player, he/she authorizes an exceptional substitution or grants a 3-minute recovery time. (see also 15.7, 17.1.2)



24.2.9: He/she checks the floor condition, mainly in the front zone. He/she also checks, during the match, that the balls still fulfill the regulations. (see also 1.2.1, 3)

### 24.3 Responsibilities

**USAV 24.3.1:** At the start of each set, at the change of courts in the deciding set (if teams will change courts) and whenever necessary, the 2nd referee checks that the actual positions of the players on the court correspond to those on the line-up sheets. (see also 5.2.3.1, USAV 7.3.2, 7.3.5, USAV 18.2.2)

- a. The 2nd referee's line-up check prior to the start of any set is a courtesy. It is the responsibility of the captain and/or coach to ensure the players maintain the correct service order once the 2nd referee has completed this line-up check.
- b. During the match, the coach or captain may request verification of player positions or may confirm the correct server. If incorrect information is provided by the 2nd referee, and the team acts directly upon this misinformation resulting in a rotational fault (wrong server), the referee's error will be corrected. The point(s) scored by the wrong server will be canceled. The team will be placed in the correct order and will resume serving from the moment the incorrect information was provided. However, if the referee's error is discovered after the opponent has served, the team at fault will retain any points scored and will be placed in the correct order. No additional point will be awarded to the opponent.

24.3.2: During the match, he/she decides, whistles and signals:

- 24.3.2.1: penetration into the opponent's court, and the space under the net (see also 11.2; diagram 5a, 11-Signal 22);
- 24.3.2.2: positional faults of the receiving team (see also 7.5; diagram 4, diagram 11-Signal 13);
- 24.3.2.3: the faulty contact of the player with the net primarily (but not exclusively) on the blocker's side and with the antenna on his/her side of the court (see also 11.3.1);
- 24.3.2.4: the completed block by back-row players or the attempted block by the Libero; or the attack hit fault by back-row players or by the Libero (see also 13.3.3, 14.6.2, 14.6.6, 23.3.2.3d, e, g; diagram 8, diagram 11-Signal 12 & 21);

- 24.3.2.5: the contact of the ball with an outside object (see also USAV 8.4.2, 8.4.3; diagram 11-Signal 15);
- 24.3.2.6: the contact of the ball with the floor when the 1st referee is not in position to see the contact (see also 8.3);
- 24.3.2.7: the ball that crosses the net plane totally or partly outside the crossing space to the opponent's court or contacts the antenna on his/her side of the court; (see also 8.4.3, 8.4.4; diagram 5a, diagram 11-Signal 15);
- 24.3.2.8: the served ball and the 3rd hit passing over or outside the antenna on his/her side of the court. (see also diagram 11-Signal 15)

**USAV 24.3.3:** At the end of the match, he/she checks the scoresheet for accuracy but is not required to sign it. (see also 23.3.3, 25.3.3)

## **RULE 25. Scorer**

### **25.1 Location**

The scorer performs his/her functions seated at the scorer's table on the opposite side of the court from and facing the 1st referee. (see also diagrams 1a, 1b, 10)

### **25.2 Responsibilities**

He/she fills in the score sheet according to the rules, cooperating with the 2nd referee.

He/she uses a buzzer or other sound device to notify irregularities or give signals to the referees on the basis of his/her responsibilities. (see also USAV 22.2.1.3)

25.2.1: Prior to the match and set, the scorer:

**USAV 25.2.1.1:** registers the data of the match and teams, including the names and numbers of the Liberos, according to the procedures in force. The captains and coaches do not sign the score sheet before the match. (see also 4.1, 5.1.1, 5.2.2, 7.3.2, 19.1.2, 19.4.2.6)

25.2.1.2 records the starting line-up of each team from the line-up sheet (or checks the data submitted electronically). (see also 5.2.3.1,

If he/she fails to receive the line-up sheets on time, he/she immediately notifies this fact to the 2nd referee.

25.2.2: During the match, the scorer:

25.2.2.1: records the points scored (see also 6.1);

- 25.2.2.2: controls the serving order of each team and indicates any error to the referees immediately after the service hit (see also 12.2);
- 25.2.2.3: is empowered to acknowledge and announce requests for player substitutions by use of the buzzer, controlling their number, and records the substitutions and time-outs, informing the 2nd referee (see also 15.1, 15.4.1, 15.10.3.3, 24.2.6, 24.2.7);
- 25.2.2.4: notifies the referees of a request for regular game interruption that is out of order (see also 15.11);
- 25.2.2.5: announces to the referees the ends of the sets, and the scoring of the 8th point in the deciding set (if a change of courts will take place);
- 25.2.2.6: records misconduct warnings, sanctions and improper requests (see also 15.11.3, 16.2, 21.3);
- 25.2.2.7: records all other events as instructed by the 2nd referee, i.e. exceptional substitutions, recovery time, prolonged interruptions, external interference, re-designation, etc. (see also 15.7, 17.1.2, 17.2, 17.3, 19.4);

**USAV 25.2.2.8:** The interval between sets is controlled by the referees. (see also 18.1)

25.2.3 At the end of the match, the scorer:

- 25.2.3.1: records the final result (see also 6.3);
- 25.2.3.2: in the case of protest, with the previous authorization of the 1st referee, writes or permits the team/game captain to write on the score sheet a statement on the incident being protested (see also USAV 5.1.2.1, 5.1.3.2, 23.2.4);

**USAV 25.2.3.3:** signs the score sheet him/herself, before obtaining the 1st referee's signature. (see also 5.1.3.1, 23.3.3)

## **RULE 26. Assistant Scorer**

### **26.1 Location**

The assistant scorer performs his/her functions seated beside the scorer at the scorer's table. (see also 22.1; diagram 1a, 1b, 10)

## 26.2 Responsibilities

He/she records the replacements involving the Libero. He/she assists with the administrative duties of the scorer's work. (see also 19.3)

Should the scorer become unable to continue his/her work, the assistant scorer substitutes for the scorer.

26.2.1: Prior to the match and set, the assistant scorer:

26.2.1.1: prepares the Libero control sheet;

26.2.1.2: prepares the reserve score sheet.

26.2.2: During the match, the assistant scorer:

**USAV 26.2.2.1:** records the details of the Libero replacements/ redesignations and all substitutions, and assists the scorer by announcing substitutions. (see also 19.3.1.1, 19.4)

26.2.2.2: notifies the referees of any fault of the Libero replacement;

**USAV 26.2.2.3:** upon request, may assist the 2nd referee with starting and ending Technical Time-outs. (see also USAV 24.2.6);

**USAV 26.2.2.4:** upon request, may assist with operating the visual scoreboard; however, it is recommended that someone other than the assistant scorer operates the visual scoreboard.

26.2.2.5: checks that the scoreboards agree;

26.2.2.6: if necessary, updates the reserve score sheet and gives it to the scorer.

**USAV 26.2.3:** does not sign the Libero control sheet or the score sheet at the end of the match. (see also 23.3.3, 25.2.3.3)

## RULE 27. Line Judges

### 27.1 Location

#### **USAV 27.1:**

When two line judges are used, they stand at the corners of the court closest to the right hand of each referee. Each one controls both the end line and sideline of his/her side.

When four line judges are used, they stand at 1m to 3m (3'3" to 9'10") from each corner of the court, on the imaginary extension of the line that they control. (see also diagram 1a, 1b, 10)

## 27.2 Responsibilities

**USAV 27.2.1:** The line judges perform their functions by using flags, 40 X 40 cm (16" X 16"); see also diagram 12. When flags are not used, the line judges will perform their functions with hand signals as shown in diagram 11-Signals 9, 14, 15, 22, and 24, to signal:

27.2.1.1: the ball "in" and "out" whenever the ball lands near their line(s) (see also 8.3, 8.4, diagram 12-Signals 1 & 2);

**USAV 27.2.1.2:** the touches of "out" balls by either team (see also 8.4; diagram 12-Signal 3);

27.2.1.3: the ball touching the antenna, the served ball and the third hit of the team crossing the net outside the crossing space, etc. (see also 8.4.3, 8.4.4, 10.1.1; diagram 5a, diagram 12-Signal 4);

27.2.1.4: any player (except the server) stepping outside of his/her court at the moment of the service hit (see also 7.4, 12.4.3; diagram 12-Signal 4);

27.2.1.5: the foot faults of the server (see also 12.4.3.);

**USAV 27.2.1.6:** any contact with the top 80cm (32") of either antenna by any player during his/her action of playing the ball or interfering with the play (see also 11.3.1, 11.4.4; diagram 3, diagram 12-Signal 4);

27.2.1.7: the ball crossing the net outside the crossing space into the opponent's court or touching the antenna on his/her side of the court. (see also 10.1.1; diagram 5a, diagram 12-Signal 4)

27.2.2: At the 1st referee's request, a line judge must repeat his/her signal.

## RULE 28. Official Signals

### 28.1 Referees' Hand Signals (diagram 11)

The referees must indicate with the official hand signal the reason for their whistle (the nature of the fault whistled or the purpose of the interruption authorized). The signal has to be maintained for a moment and, if it is indicated with one hand, the hand corresponds to the side of the team which has made the fault or the request.

### 28.2 Line Judges' Flag Signals (diagram 12)

The line judges must indicate with the official flag signal the nature of the fault called and maintain the signal for a moment.





---

SECTION IV

---

**DIAGRAMS, U-VOLLEY,  
CO-ED & PARAVOLLEY**





## Diagram 1b: The Playing Area

Relevant Rules: 1, 1.4, 1.4.2, 1.4.3, 1.4.4, 1.4.5, 1.4.6, 4.2.1, 4.2.3.1, 15.10.1, 19.3.1.4, 19.3.2.7

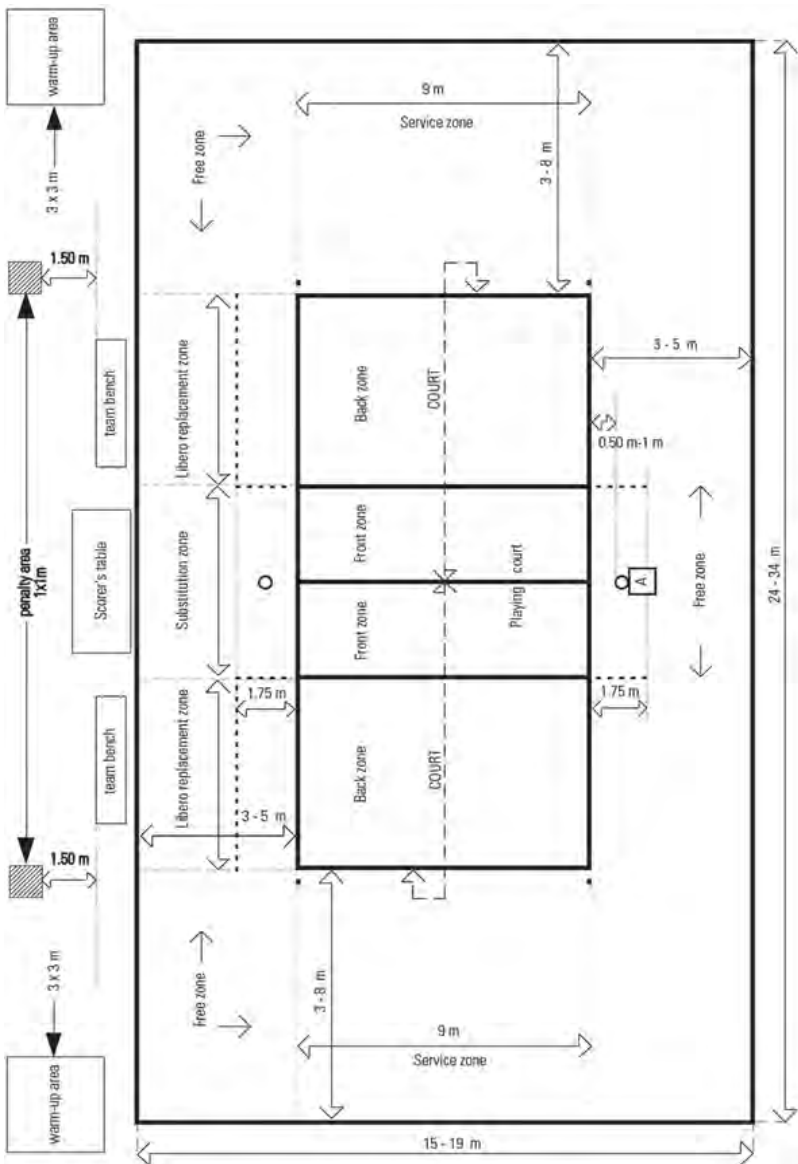

## Diagram 2: The Playing Court

Relevant Rules: 1.1, 1.3, 1.3.3, 1.3.4, 1.4.1, USAV 5.2.3.4

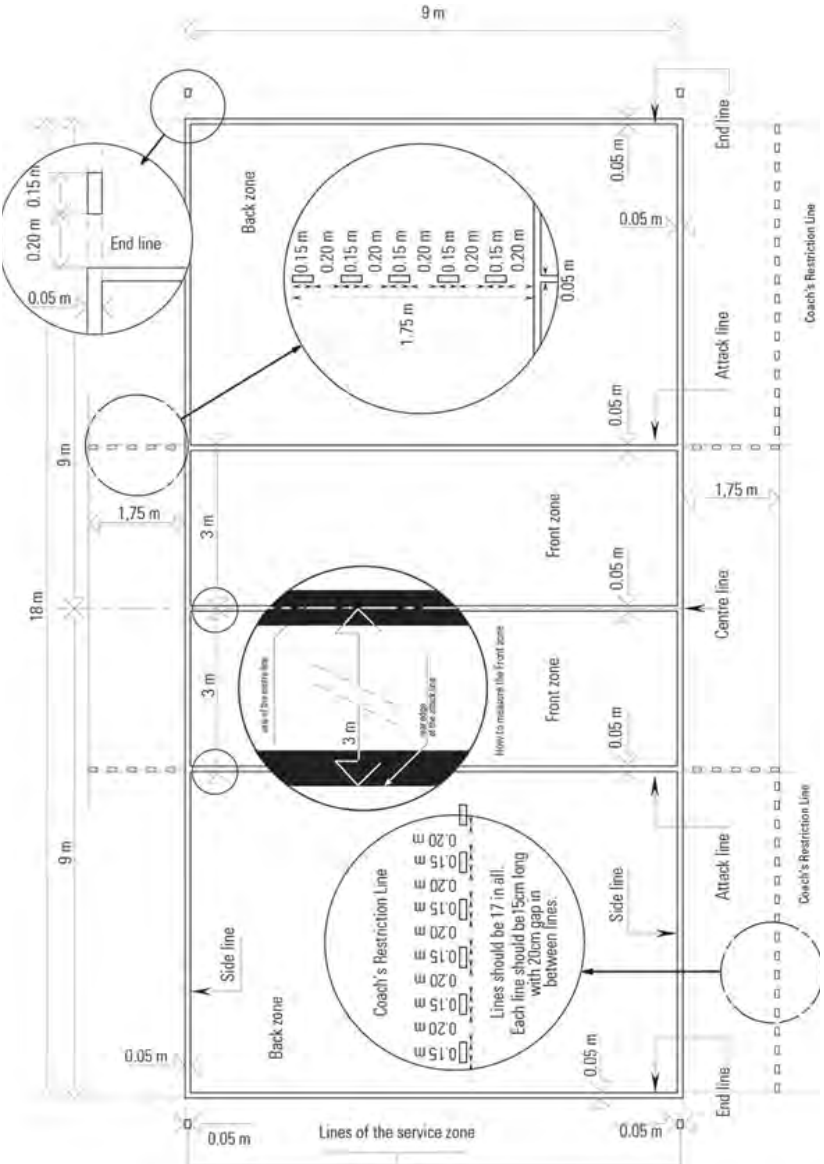

### Diagram 3: Design Of The Net

Relevant Rules: 2, 2.1.6, 2.2, 2.3, 2.4, 2.5.1, 11.3.1, 11.3.2, 27.2.1.6

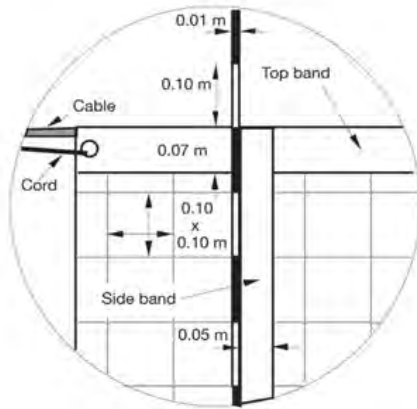
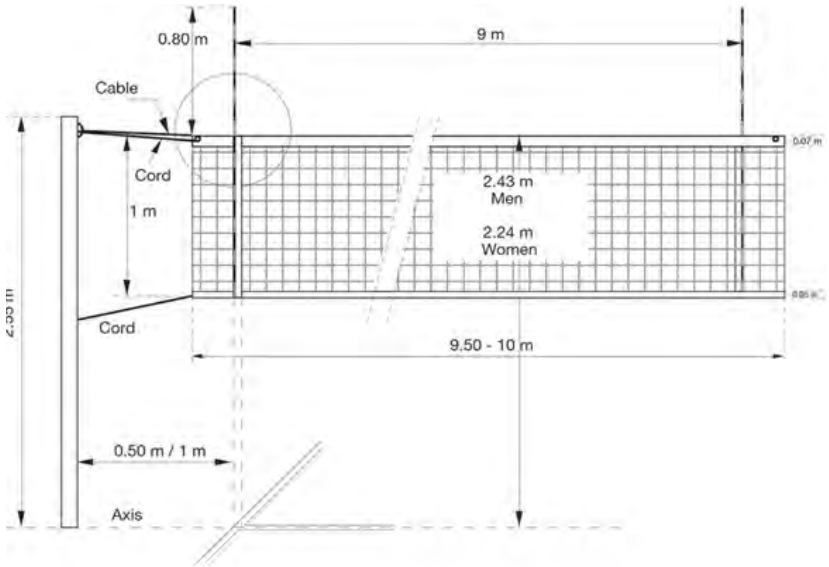

#### Diagram 4: Position of Players

Relevant Rules: 7.4, 7.4.3, 7.5, 23.3.2.3A, 24.3.2.2

##### Example A:

Determination of the positions between a front-row player and the corresponding back-row player

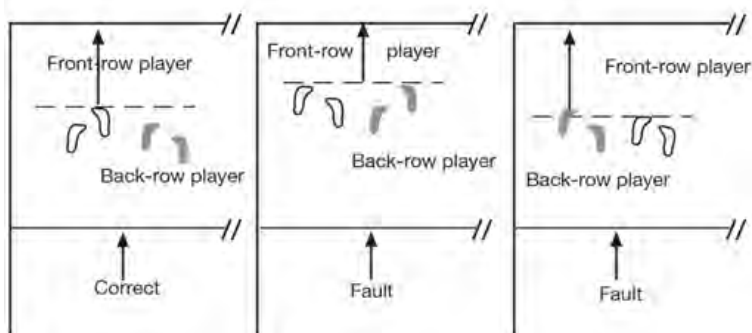

##### Example B:

Determination of the positions between players of the same row

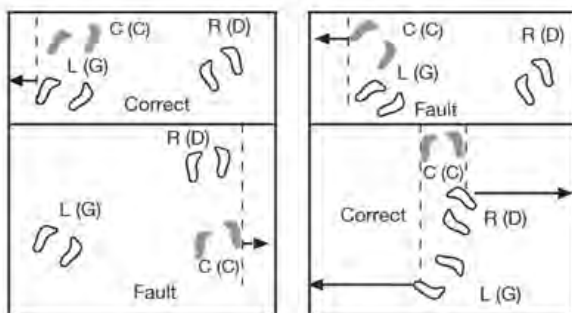

C (C) = Centre player  
 R (D) = Right player  
 L (G) = Left player

## Diagram 5a: Ball Crossing the Vertical Plane of the Net to the Opponent Court

Relevant Rules: 2.4, 8.4.3, 8.4.4, 8.4.5, 10.1.1, 10.1.3, 24.3.2.7, 27.2.1.3, 27.2.1.7

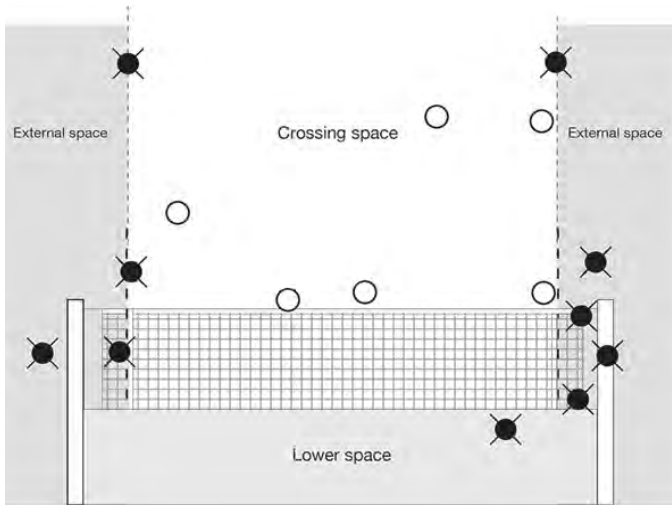

- = Fault
- = Correct crossing

**Diagram 5b: Ball Crossing The Vertical Plane Of The Net To The Opponent Free Zone**

Relevant Rules: 10.1.2, 10.1.2.2, 24.3.2.7

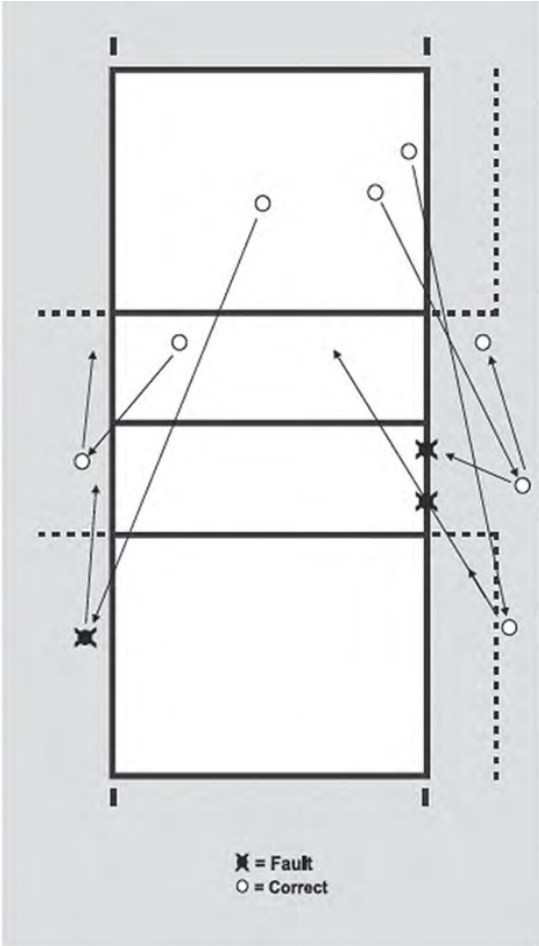

### Diagram 6: Collective Screen

Relevant Rules: 12.5, 12.5.2, 23.3.2.3a

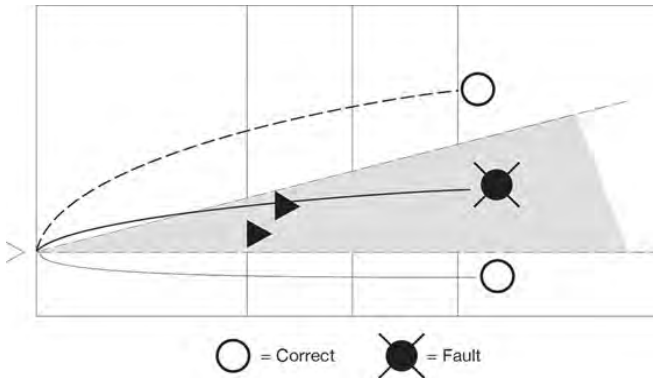

### Diagram 7: Completed Block

Relevant Rules: 14.1.3

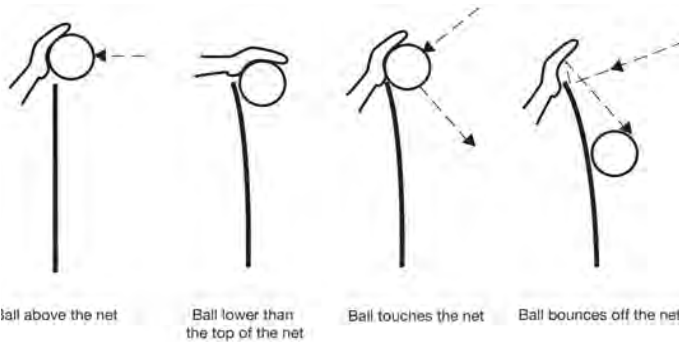

# Diagram 8: Back-Row Player's Attack

Relevant Rules: 13.2.2, 13.2.3, 23.3.2.3d, 24.3.2.4

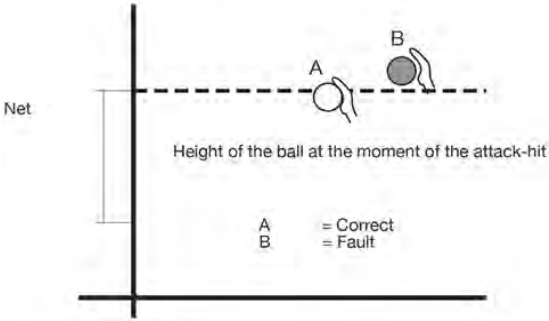
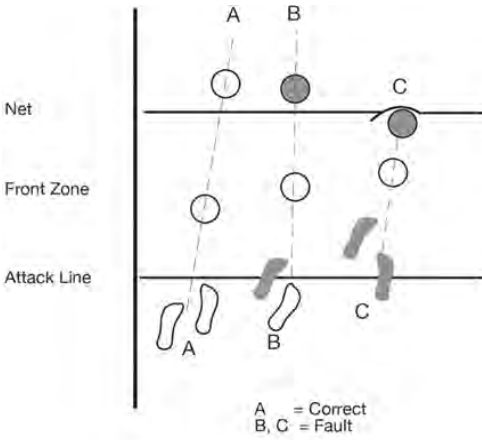



## Diagram 9: Warnings And Sanctions Scales And Their Consequences

Relevant Rules: 16.2, 21.3, 21.4.2

NOTE: The application of the yellow card is not a sanction. Sanctions are shown in the table below.

### DIAGRAM 9: WARNINGS AND SANCTIONS SCALES AND THEIR CONSEQUENCES

Relevant Rules: 16.2, 21.3, 21.4.2

#### 9a: MISCONDUCT WARNINGS AND SANCTIONS

CATEGORIES	OCCURRENCE	OFFENDER	SANCTION	CARDS	CONSEQUENCE
MINOR MISCONDUCT	Stage 1	Any member	Not considered as sanction	None	Prevention only
	Stage 2			Yellow	
	repetition any time		Penalty	as below	as below
RUDE CONDUCT	First	Any member	Penalty	Red	A point and service to the opponent
	Second	Same member	Expulsion	Red + Yellow jointly	Player leaves playing area and stays in the penalty area for the remainder of the set.
	Third	Same member	Disqualification	Red + Yellow separately	Player leaves the Competition-Control Area for the remainder of the match
OFFENSIVE CONDUCT	First	Any member	Expulsion	Red + Yellow jointly	Player leaves the playing area and stays in the penalty area for the remainder of the set
	Second	Same member	Disqualification	Red + Yellow separately	Player leaves the Competition-Control Area for the remainder of the match
AGGRESSION	First	Any member	Disqualification	Red + Yellow separately	Player leaves the Competition-Control Area for the remainder of the match

#### 9b: DELAY WARNING SYMBOLS AND SANCTIONS

CATEGORIES	OCCURRENCE	OFFENDER	DETERRENT or SANCTION	CARDS	CONSEQUENCE
DELAY	First	Any member of the team	Delay Warning	Hand signal No. 25 with Yellow card	Prevention – no penalty
	Second and subsequent	Any member of the team	Delay Penalty	Hand signal No. 25 with Red card	A point and service to the opponent

### Diagram 10: Location of Refereeing Corps and Their Assistants

Relevant Rules: 3.3, 23.1, 24.1, 25.1, 26.1, 27.1

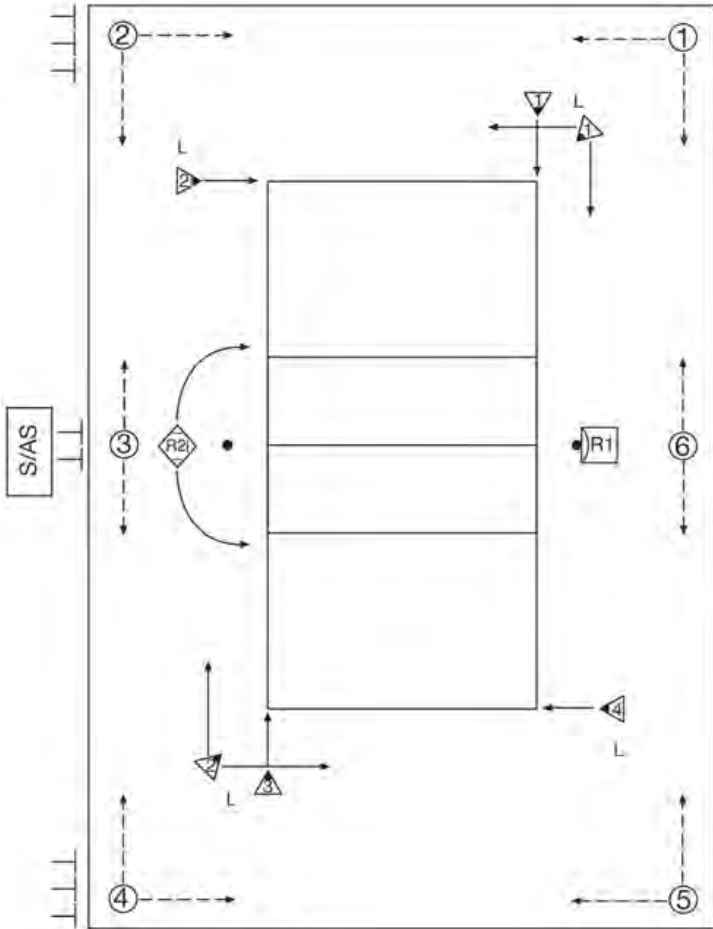

- R1 = First Referee
- ◆ R2 = Second Referee
- S/AS = Scorer/Assistant Scorer
- ▶ = Lines Judges (numbers 1-4 or 1-2)
- ④ = Ball Retrievers (numbers 1-8)
- └ = Floor Moppers

## OFFICIAL HAND SIGNALS

### Diagram 11: Referees' Official Hand Signals

1. All signals which are made with one hand shall be made with the hand on the side of the team that commits the fault or makes the request.
2. After the signal is made, the referee gestures to the player who has committed the fault or the team that has made the request.



First or Second referee(s) who must show the signal according to their regular responsibilities.



First or Second referee(s) who must show the signal in special situations.

### 1. Authorization Serve

Relevant Rules: 3.3, 23.1, 24.1, 25.1, 26.1, 27.1

Move the hand to indicate the direction of service.



## 2. Team Serve

Relevant Rules: 22.2.3.1, 22.2.3.2, 22.2.3.4

Extend the arm to the side of the team that will serve.

F S



## 3. Change of Courts

Relevant Rules: 18.2

When the change of courts protocol is used, raise the forearms front and back and twist them around the body.

F



## 4. Time-Out

Relevant Rules: 3.3, 23.1, 24.1, 25.1, 26.1, 27.1

Place the palm of one hand over the fingers of the other, held vertically (forming a "T") and then indicate the requesting team. NOTE: Used by 1st referee when he/she whistles the time-out.

F S



## 5. Substitution

Relevant Rules: 15.5.1, 15.5.2, 15.8

Circular motion of the forearms around each other.

NOTE: Used by 1st referee when he/she whistles the substitution.



## 6. Misconduct Warning and Misconduct Penalty

Relevant Rules: 21.1, 21.6, 21.3.1, 23.3.2.2

- 6a. Show a yellow card for warning.
- 6b. Show a red card for penalty.



## 7. Expulsion

Relevant Rules: 21.3.2, 21.6, 23.3.2.2

Show both cards jointly for expulsion.



## 8. Disqualification

Relevant Rules: 21.3.3, 21.6,  
23.3.2.2

Show red and yellow cards separately  
for disqualification.

F



## 9. End of Set (or Match)

Relevant Rules: 6.2, 6.3

Cross the forearms in front of the  
chest, hands open.

F

S



## 10. Ball Not Tossed or Released at the Service Hit

Relevant Rules: 12.4.1

Lift the extended arm, the palm of  
the hand facing upwards.

USAV: Substitute authorization to  
enter; 2nd referee only.

F

S



## 11. Delay in Service

Relevant Rules: USAV 12.4.4

Raise eight fingers, spread open.

F



## 12. Blocking Fault, Screening or Ready Signal

Relevant Rules: 12.5, 12.6.2.3,  
14.6.3, 19.3.1.3, 23.3.2.3a/g,  
24.3.2.4

Raise both arms vertically, palms  
forward.

F

S



## 13. Positional or Rotational Fault or Screening

Relevant Rules: 7.5, 7.7, 23.3.2.3a,  
24.3.2.2

Make a circular motion with the  
forefinger.

F

S



#### 14. Ball "In"

Relevant Rules: 8.3

Point the arm and the fingers toward the floor.



#### 15. Ball "Out"

Relevant Rules: 9.2.2, 9.3.3,  
23.3.2.3b

Raise the forearms vertically, hands open, palms toward the body.



#### 16. Catch

Relevant Rules: 6.2, 6.3

Slowly lift the forearm, palm of the hand facing upwards.





### 17. Double Contact

Relevant Rules: 9.3.4, 23.3.2.3b

Raise two fingers, spread open.

F



### 18. Four Hits

Relevant Rules: 9.3.1, 23.3.2.3b

Raise four fingers, spread open.

F



### 19. Net Touched by Player/Served Ball Does Not Pass Vertical Plane of the Net

Relevant Rules: 11.4.4, USAV  
12.6.2.1

Indicate the relevant side of the net with the corresponding hand. For service fault, only 1st referee signals.

F

S



## 20. Reaching Beyond the Net

Relevant Rules: 11.4.1, 13.3.1, 14.3, 14.6.1, 23.3.2.3c

Place a hand above the net, palm facing downwards.

F



## 21. Attack-Hit Fault

-by a back-row player, by a libero or on the opponent's service

Relevant Rules: 13.3.3, 13.3.4, 13.3.5, 23.3.2.3d, e, 24.3.2.4

-on an overhand finger pass by the libero in his/her front zone or its extension

Relevant Rules: 13.3.6

Make a downward motion with the forearm, hand open.

F

S



## 22. Penetration into the Opponent Court/Line Fault

Ball Crossing the Lower Space, or

Server Touches the Court (End Line), or

Player Steps Outside Court at Moment of Service Hit

Relevant Rules: 8.4.5, 11.2.2, USAV 12.4.3, 23.3.2.3a/f, 24.3.2.1

Point to the center line or to the relevant line.

F

S



## 23. Double Fault and Replay

Relevant Rules: 6.1.2.2, 17.2, 22.2.3.4

Raise both thumbs vertically.

F

S



## 24. Ball Touched

Relevant Rules: 23.3.2.3b, 24.2.2

Brush with the palm of one hand the fingers of the other, held vertically.  
USAV: Brush fingers of opposite hand once over palm of vertical hand with upward motion.



## 25. Delay Warning/Delay Penalty

Relevant Rules: 15.11.3, 16.2.2,  
16.2.3, 23.3.2.2

Cover the wrist with a yellow card (warning) and with a red card (penalty).

USAV: Without card, hold palm of one hand against the opposite wrist for Improper Request.



## 26. Illegal Contact (used in Co-Ed competition)

Relevant Co-Ed Rules: 1.2, 1.2.1,  
1.2.2

USAV: Place hands together (palms facing each other) overhead.



## Diagram 12: Line Judges' Official Flag Signals (Indoor)

### 1. Ball "In"

Relevant Rules: 8.3, 27.2.1.1

Point down with flag.



### 2. Ball "Out"

Relevant Rules: 8.4.1, 27.2.1.1

Raise flag vertically.



### 3. Ball Touched

Relevant Rules: 27.2.1.2

Raise flag and touch the top with the palm of the free hand.



### 4. Crossing Space Faults, Ball Touched Outside Object, Foot Fault

Relevant Rules: USAV 8.4.2, 8.4.3, 8.4.4, USAV 12.4.3, 27.2.1.3, 27.2.1.4, 27.2.1.6, 27.2.1.7

Wave flag over the head and point to the antenna or the respective line.



### 5. Judgment Impossible

Raise and cross both arms and hands in front of the chest.



## DEFINITIONS

**AREAS:** These are sections of the floor OUTSIDE the free zone, identified by the rules as having a specific function. These include: warm-up area and penalty area.

**BALL RETRIEVERS AND MOPPERS:** These are personnel whose job it is to maintain the flow of the game by rolling the ball to the server between rallies.

Moppers are personnel whose job it is to keep the floor clean and dry. They mop the court before the match, between the sets and, if necessary, after each rally.

**COMPETITION/CONTROL AREA:** The Competition/Control Area is a corridor around the playing court and free zone, which includes all spaces up to the outer barriers or delimitation fence. See diagram/figure 1a.

**CONTRAST:** When referring to uniforms, “contrast” refers to dark versus light colors.

**CROSSING SPACE:** The crossing space is defined by:

- The horizontal band at the top of the net
- The antennae and their extension
- The ceiling

The ball must cross to the opponent’s COURT through the crossing space.

**DRIBBLING:** Dribbling means bouncing the ball (usually as a preparation to tossing and serving). Other preparatory actions could include (amongst others) moving the ball from hand to hand.

**EXTERNAL SPACE:** The external space is in the vertical plane of the net outside of the crossing and lower spaces.

**FAULT:** a) A playing action contrary to the rules; b) A rule violation other than a playing action.

**FIVB STANDARDS:** The technical specifications or limits as defined by FIVB to the manufacturers of equipment.

**INTERFERING:** Any action which will create an advantage against the opponent team or any action which prevents an opponent from playing the ball.

**INTERVAL:** The time between sets. The change of courts in the 3rd or 5th (deciding) set is not to be regarded as an interval.

**LOWER SPACE:** This is the space defined at its upper part by the bottom of the net and the cord joining it to the posts, at the sides by the posts, and the bottom by the playing surface.

**OUTSIDE OBJECT:** An object or a person which while outside the playing court or close to the limit of the free playing space provides an obstruction to the flight of the ball. For example: overhead lights, the referee's chair, TV equipment, scorer's table, and net posts. Outside objects do not include the antennae since they are considered as the part of the net.

**PENALTY AREA:** In each half of the competition/control area, there is a Penalty Area located behind the prolongation of the end line, outside the free zone, which should be placed a minimum of 1.5 meters behind the rear edge of the bench.

**RALLY POINT:** This is the system of scoring a point whenever a rally is won.

**RE-DESIGNATION:** This is the act by which a Libero, who cannot continue or is declared by the team "unable to play," has his/her role taken by any other player (except the regular replacement player) not on the court at the moment of the re-designation.

**REPLACEMENT:** This is the act by which a regular player leaves the court and either Libero (if more than one) takes his/her place. This can even include Libero for Libero exchanges. The regular player can then replace either Libero. There must be a completed rally between replacements involving any Libero.

**SUBSTITUTION:** This is the act by which one regular player leaves the court and another regular player takes his/her place.

**SUBSTITUTION ZONE:** This is the part of the free zone through which substitutions are carried out.

**TECHNICAL TIME-OUT:** This special mandatory time-out is, in addition to time-outs, to allow the promotion of volleyball, analysis of the play and to allow additional commercial opportunities. Technical Time-Outs are mandatory for FIVB, World and Official competitions.

**UNLESS BY AGREEMENT OF FIVB:** This statement recognizes that while there are regulations on the standards and specification of equipment and facilities, there are occasions when special arrangements can be made by FIVB in order to promote the game of volleyball or to test new conditions.

**ZONES:** These are sections within the playing area (i.e. playing court and free zone) as defined for a specific purpose (or with special restrictions) within the rule text. These include: Front Zone, Service Zone, Substitution Zone, Free Zone, Back Zone, and Libero Replacement Zone.



## U-VOLLEY RULES

### HEIGHT RESTRICTIONS

All players shall conform to the height restrictions as prescribed by FIVB rules, which are “under 185 centimeters” (approximately 72.83 inches) for men and “under 175 centimeters” (approximately 68.89 inches) for women.

Height measurement will be in stocking feet or bare feet (without shoes). All players close to this limitation are subject to individual measurement prior to competition during pre-tournament check-in and during random checks throughout the tournament.

USAV: For ease of administration, the height of 6’1” for men and 5’9” for women may be used for recreational play.

## CO-ED RULES

The following Rules govern co-ed and reverse co-ed competition. The Rules Commission solicits comments and suggestions from volleyball groups and organizations that conduct and sponsor special competitions such as doubles, triples, mixed doubles, etc.

### **1. CO-ED PLAY**

The Indoor Rules Book in general shall govern play for females and males on the same team with the following exceptions:

#### **1.1 The serving order and positions on the court at service shall be male and female alternated or vice-versa.**

1.1.1 A team may list two specialized defensive players, “Liberos,” per match or one Libero per set. More information can be found under Rule 19 and USAV 19.1.1.

1.1.1.1 Alternating male and female service order must be maintained. A female Libero may only replace regular female players. A male Libero may only replace regular male players. All other Libero rules and restrictions apply.

1.2 When the ball is played more than once by a team, a female player shall make at least one of the contacts. Contact of the ball during blocking shall not constitute playing the ball. There is no requirement for a male player to contact the ball, regardless of the number of hits by a team.

- 1.2.1 If a team contacts the ball more than one time during offensive action, one of the contacts must be by a female player, but there is no restriction preventing all three team hits from being made by female players. Contact of the ball during blocking action does not count as one of the three team hits. Therefore, after a block, a male player may play the ball back over the net as such contact would be considered the first team hit.
  - 1.2.2 A ball contacted more than once by a team, without a female player having contacted it, remains live and does not become an illegal hit until it fully crosses the plane of the net or is contacted by an opponent.
  - 1.2.3 An illegally hit ball blocked by an illegal blocker results in a double fault, and a replay is directed.
- 1.3 Uniforms of players shall be identical within the following provisions:**
- 1.3.1 All female players shall be attired in identical jerseys and shorts or one-piece uniforms.
  - 1.3.2 All male players shall be attired in identical jerseys and shorts or one-piece uniforms.
  - 1.3.3 All uniforms shall be numbered in compliance with USAV Rule 4.3.3. There shall be no duplicate numbers, regardless of color of the jerseys or gender of the player.
- 1.4 When only one male player is in the front row at service, one male back-row player may be forward of the attack line for the purpose of blocking. The remaining back-row player must be behind the attack line until the ball has been contacted by the blocker(s) or has been hit in such a manner that no block is possible.**
- Commentary: If a back-row player is not participating in a block, there is no restriction on both back-row male players being in the attack zone.**
- 1.4.1 The provisions of Rule 13.2.2 shall govern male back-row players when playing the ball in other than blocking actions.
  - 1.4.2 No female back-row player may participate in a block.
- 1.5 The height of the net for mixed-six play shall be 2.43 m (7'11 5/8").**
- 1.5.1 Where age group mixed-six competition is conducted, the height of the net shall be that prescribed for men's competition in the respective age group. In order to protect the safety of the competitors, this shall not be modified.

## **2. REVERSE CO-ED PLAY**

The Indoor Rules Book as Presented by USAV in general shall govern play for females and males on the same team with the following exceptions:

- 2.1 The serving order and positions on the court at service shall be male and female alternated or vice-versa.**
- 2.2 When the ball is played more than once by a team, a male player shall make at least one of the contacts. Contact of the ball during blocking shall not constitute playing the ball. There is no requirement for a female player to contact the ball, regardless of the number of hits by a team.**
  - 2.2.1 If a team contacts the ball more than one time during offensive action, one of the contacts must be by a male player, but there is no restriction preventing all three team hits from being made by male players. Contact of the ball during blocking action does not count as one of the three team hits. Therefore, after a block, a female player may play the ball back over the net as such contact would be considered the first team hit.
  - 2.2.2 A ball contacted more than once by a team, without a male player having contacted it, remains live and does not become an illegal hit until it fully crosses the plane of the net or is contacted by an opponent.
- 2.3 Uniforms of players shall be identical within the following provisions:**
  - 2.3.1 All female players shall be attired in identical jerseys and shorts or one- piece uniforms.
  - 2.3.2 All male players shall be attired in identical jerseys and shorts or one-piece uniforms.
  - 2.3.3 All uniforms shall be numbered in compliance with USAV Rule 4.3.3. There shall be no duplicate numbers, regardless of color of the jerseys or gender of the player.
- 2.4 When only one female player is in the front row at service, one female back- row player may be forward of the attack line for the purpose of blocking. The remaining female back-row player must be behind the attack line until the ball has been contacted by the blocker(s) or has been hit in such a manner that no block is possible.**

Commentary: If a back-row player is not participating in a block, there is no restriction on both back-row female players being in the attack zone.

- 2.4.1 The provisions of Rule 13.2.2 shall govern female back-row players when playing the ball in other than blocking actions.
- 2.4.2 No male player may participate in a block.
- 2.5 **Male players may attack the ball from above the height of the net and direct it to enter the opponent's court so long as the ball has an upward trajectory immediately after contact.**
- 2.6 The height of the net for reverse co-ed play shall be 2.24 m (7'4 1/8").

## GUIDE TO PHYSICALLY CHALLENGED VOLLEYBALL

From minimal to major disabilities, statistics indicate seven percent of any population is physically challenged. This guide gives you the opportunity to promote volleyball to those with whom you may cross paths who are physically challenged and want to play our great game! Volleyball easily fits with the motto of Disabled Sports/USA: "If I Can Do This, I Can Do Anything."

Along with wheelchair basketball, sitting volleyball has become one of the most widely played and most popular sports in the disabled society. In some parts of the world, the matches are televised. Disabled volleyball is played with participants standing, sitting and in wheelchairs. The sport allows for participation by amputees, as well as cerebral palsy athletes.

We urge you to take the time to teach anyone how to play the sitting version, even if over a rope in a classroom on a night you might have lost the main gym. Please take the time to find those athletes aspiring to play volleyball and join with them in training, either in standing or sitting versions...you'll be amazed.

### Volleyball — An Ideal Sport for the Disabled

Volleyball is a team sport which can be played by the physically challenged and able-bodied athletes. It can be played by youth, juniors, adults and seniors in any combination. Unlike many sports, volleyball can be played at all levels co-educationally, creating a gregarious and integrating atmosphere that is appreciated by all involved.

Volleyball is a uniquely universal sport, as it includes persons of minor disability, as well as people who are more severely disabled. Top international sitting teams use setters who are double-leg amputees and these athletes are much faster in on-court movement.

Volleyball practice is economical, especially for sitting volleyball, since no expensive prostheses, wheelchairs and special sport equipment are needed. All that is needed is floor space, a rope or net, and a ball.

### DISABLED VOLLEYBALL HISTORY

The need for physically challenged people to compete in sport arose during and after World War II. The rehabilitation process for disabled veterans progressed at a quicker pace when a sporting activity was involved in stimulating recovery. After the war, sitting volleyball was invented in The Netherlands. The first competitive international match was played in 1957.

Disabled Sports/USA (DS/USA), founded in 1976, is the national organization

chartered to provide access to year-round, grassroots sports and recreational programs for children and adults with disabilities. The organization supports the vertical integration of disabled athletes into the National Governing Bodies (NGBs) of the United States Paralympics (USP) on an equivalent basis. The USP was formed in 2001 as part of the U.S. Olympic Committee (USOC) and works with USA Volleyball (USAV) in the development and training of the USA Women's and Men's National Sitting Teams for international World Championships and the Paralympics.

Volleyball's international governing body for physically challenged athletes is World ParaVolley (WPV). WPV oversees international championships and tournaments worldwide to include zonal championships, Intercontinental Cup, World Championships and the Paralympic Games. For more information, log onto [www.worldparavolley.org](http://www.worldparavolley.org).

### Standing Volleyball

Standing volleyball is played by regular volleyball rules with one exception: on-court player rankings of "A", "B" or "C". The six players on court must include a minimum of one "C" class player, and may include a maximum of one "A" class player. If a Libero is on court, the six players must still satisfy this requirement. This is known as a classification system. Players are not classified "A", "B" or "C" by their ability to play, but by the severity of their disability. "A" is considered a minimum disability and "C" would be someone with a more severe disability.

A complete set of rules for standing volleyball can be found and downloaded from the World ParaVolley website at [www.ParaVolleyPanAm.com/resources](http://www.ParaVolleyPanAm.com/resources).

### Sitting Volleyball

A complete set of rules for sitting volleyball can be found and downloaded from the ParaVolley Pan America (PVPA) website at [www.ParaVolleyPanAm.com/resources](http://www.ParaVolleyPanAm.com/resources).

The regulation sitting court size is 10m x 6 m (32' 9<sup>3</sup>/<sub>4</sub>" x 19' 8<sup>1</sup>/<sub>4</sub>"). Boundary lines are included in the court. The centerline divides the court into two courts, 6 m x 5 m (19' 8 1/4" x 16<sup>4</sup> 7/8") each. A racquetball court is almost perfectly sized, especially when using a lowered Wallyball net. The lines of a regular court using two linked nets down the middle allow for three courts (end line to 3-meter line; 3-meter line to 3-meter line; 3-meter line to end line).

A net that is 1 m wide and 10 m long is attached to the standards of a 9 m x 18 m court. (Internationally, a regulation net is 80 cm wide and 6.5 m long). The net height is 1.15 m (45 1/4") for men and 1.05 m (41 1/3") for women.

The attack lines are drawn parallel to the centerline, 2 m from the middle of

the centerline. The service zone is marked with two lines, each 15 cm long and placed inside the service zone at the end of each court, 20 cm behind and perpendicular to the end line. Both are drawn as an extension of each sideline.

The court size and height of the net may be modified for sitting volleyball. Modifications to gym space are acceptable for local play, as long as both courts are equal in size.

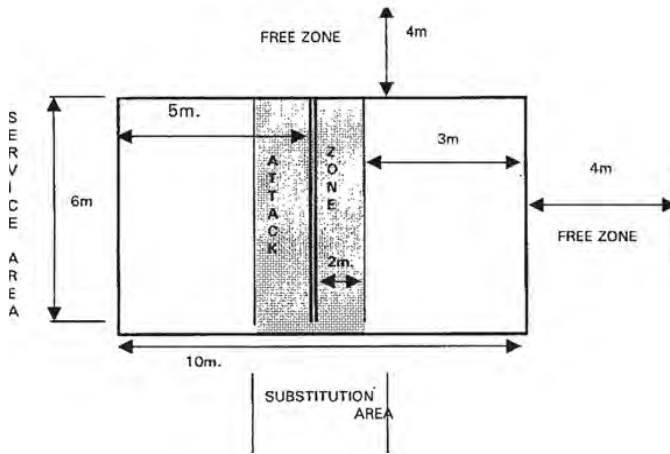

## KEY RULE MODIFICATIONS FOR SITTING VOLLEYBALL

- The position of each player is determined and controlled by the position of his/her bottom. This means that at the time of service, the hand(s) and/or legs of back-court players may lie in the attack zone, and that the hand(s) and/or legs of on-court players may lie off court.
- “Bottom” is defined as the upper part of the body, from the shoulder to one’s buttocks.
- It is permitted to touch the opponent’s court beyond the centerline with any part of the body provided that it does not interfere with the opponent’s play.
- At all times during playing actions, the players must contact the court with some part of the body between the buttocks and the shoulders, except that a short loss of contact with the court is permitted when playing the ball, excluding the service, the block and attack hit when the ball is completely higher than the top of the net. To stand up, raise the body or take steps is forbidden.

- The back-row player may perform any type of attack-hit from any height, if at the time of the hit the bottom does not touch or cross over to the attack line.
- The referee's official hand signal of "lifting from the court" is made by raising the upper hand and forearm positioned parallel to the floor and mirror imaging the lower hand and forearm.
- Referees in sitting volleyball must stand to the sides of the court because of the height of the net and the fact that the players are in a seated position.
- Blocking or attacking a served ball is permitted.

## PARALYMPICS

Volleyball has been a Paralympic discipline for more than 20 years. The first Paralympics were conducted in 1960 in Rome, although the expression "The Paralympic Games" was first used in 1984. Although in the beginning it only included men's competition, women's sitting volleyball was added to the Athens 2004 Summer Paralympics. In the 2004 Athens Games, the U.S. women's sitting team earned a bronze medal; and the men, although ending up in sixth place, earned valuable international experience.

The U.S. women's sitting team won the silver medal at the 2008 and 2012 Paralympics in Beijing and London, and then made history by winning back-to-back gold medals in Rio 2016 and Tokyo 2020. The U.S. men traveled to Rio in 2016 and came away with an eight-place finish at the Paralympics. The U.S. men did not qualify for Tokyo 2020.

World ParaVolley (WPV) is working diligently to introduce Standing Beach ParaVolley as a Paralympic sport at the 2028 Los Angeles Paralympic Games. USA Volleyball is a leader in marketing, training and hosting competitions for the Pan America Zone, as well as internationally. In October 2021, Hickory Point Beach in Tavares, Florida, was approved by WPV to be the first Beach ParaVolley Development Center in the world. This 21 court facility will provide excellent opportunities to train USA Para-Athletes, and also to host zonal and international competitions.

The USA strives to identify and train the top American athletes for men's and women's sitting and men's standing volleyball. In 2009, Bill Hamiter was selected as the first high performance director and resident head coach for the U.S. Sitting Teams, which are based at the University of Central Oklahoma (UCO) in Edmond. He works closely with Elliot Blake, the sitting volleyball coordinator at UCO.



## USA NATIONAL CHAMPIONSHIPS

The U.S. Standing Volleyball Team competed in the “A” Division at the 2003 U.S. National Championships in Minneapolis, MN – an event designed for non-disabled athletes. The Sitting Men’s and Women’s Teams also use the Open National Championships and various Junior Qualifiers as training and talent awareness stops on their quadrennial journey to the Paralympics. Sitting volleyball was added as a discipline at the USA Volleyball Open National Championships in May 2016 in Orlando, FL, where 10 teams participated. There is no requirement for players to be physically challenged to participate in this division at the USA Volleyball Open National Championships.

Disabled Sports/USA annually holds the National Amputee and Les Autres Games, including the Standing and Sitting Volleyball National Championships. Teams need three disabled players on the roster and two disabled players on the court at all times.

### Resources

If you would like to play, organize or coach a disabled volleyball team, including establishing a volleyball program in your area, please check out [www.usavolleyball.org](http://www.usavolleyball.org).

For more information on WPV officiating in the United States, contact Joe Campbell at (713) 702-9516 (cell) or [iokepa1@yahoo.com](mailto:iokepa1@yahoo.com).

For more information on the sitting team programs at UCO, contact

Elliot Blake  
(405) 974-3153  
[jblake1@uco.com](mailto:jblake1@uco.com)

Bill Hamiter  
(405) 974-3138  
[bill.hamiter@usav.org](mailto:bill.hamiter@usav.org)





---

**SECTION V**

---

**OFFICIATING**

## REFEREE TECHNIQUES

1. **Roster verification:** Rosters, if used, are verified pre-match by the scorer, assisted by the 2nd referee. Both referees visually review uniforms for legality.
2. **Coin toss procedures:** USA Volleyball does not designate “home” or “visitor” teams, so the 1st referee designates a side of the coin for each team during the pre-match and deciding set coin tosses. The coin is tossed and caught, and the result immediately revealed without turning the coin over. If the coin is dropped, it shall be re-tossed. The captain who wins the coin toss has the options of serving or receiving the serve, or the side of the court to occupy. The opposing captain then chooses from the remaining options.

NOTE: We recognize that junior teams often have more than one player serving as team/game captain, and that special team circumstances may result in the coach sending multiple players to the captains’ meeting. It is acceptable for multiple team representatives to attend the captains’ meeting, and the 1st referee will need to confirm which player will be representing the team for the toss.

3. **Pre-set line-up check:** When checking line-ups at the start of each set, the 2nd referee stands at the sideline of each team’s court with both teams’ line-up sheets in hand to verify player positions. The 2nd referee does not enter the court. The scorer and assistant scorer are recommended to use the score sheet and Libero Control Sheet, respectively, to verify player positions with the 2nd referee to help ensure the correct players are on the court for each team. The game ball remains at the scorer’s table until line-ups have been verified and Libero replacements authorized. Once the line-up sheets have been returned to the scorer, the game ball is tossed or rolled to the first server.
4. **Referee signal sequence:**
  - a. When the fault is whistled by the 1st referee, the 1st referee indicates which team wins the rally by extending the arm in the direction of the team that is to serve next (palm perpendicular to floor), then signals the nature of the fault and the player at fault, if necessary (Rule 22.2.3.1). All signals are repeated by the 2nd referee except the authorization to serve and a served ball that fails to pass to the opponent through the crossing space.

- b. When the fault is whistled by the 2nd referee, the 2nd referee indicates the nature of the fault and the player at fault, if necessary. The 1st referee then indicates the next team to serve and the 2nd referee repeats that signal. The 1st referee does not signal the fault or player at fault (Rule 22.2.3.2).

5. **2nd referee position at end of rally:**

- a. When the 2nd referee's whistle ends a rally, he/she will step to the offending team's side of the net before signaling the fault.
- b. When the 1st referee's whistle ends the rally, the 2nd referee steps to the offending team's side of the net and repeats the signals of the 1st referee. When facilities do not present enough space for the 2nd referee to easily step to the offending team's side, the 2nd referee simply steps laterally away from the post and repeats the 1st referee's signal sequence.

NOTE: When the 2nd referee has relevant playing-ending information or is offering discreet assistance, he/she must avoid transitioning and signaling simultaneously, which may result in the information or signal being obstructed by the net post or equipment.

- 6. **Attack Hit Fault signal (Signal 21):** Completely extend the arm straight up, above the shoulder, hand open, and then bending at the elbow, make a downward motion toward the opposing team. The final position of the arm should not obstruct the referee's view.
- 7. **Blocking fault/screening signal (Signal 12):** Completely extend both arms straight up from the shoulders (elbows are not bent), palms facing away from the body.
- 8. **Improper request signal & technique:** An improper request is signaled with a "wave off" – a sweeping motion with the arm extended, open hand, palm facing away from the body, on the offending team's side of the court. The 2nd referee communicates this to the coach at the earliest opportunity, without delaying the match. At the end of the rally, the 1st referee signals the improper request by placing the palm over the opposite wrist, on the offending team's side of the court. The improper request is recorded on the score sheet at the end of the rally.
- 9. **Same player makes third and fourth team hits:** Signal "double contact" (Signal 17).

10. **Indication of which player(s) contacted the net:** Indicate the player at fault by pointing toward the player with an open hand.
11. **Completed attack-hit from an overhand set by a Libero in the front zone:** Signal attack hit fault (Signal 21), and then indicate the Libero by pointing toward the Libero with an open hand.
12. **Identification of game captain:** During pre-match line-up checks, the 2nd referee indicates the game captain to the 1st referee by placing the arm in the chest area, hand open and palm facing the floor, and then pointing, open hand, toward this player. This technique should also be used when the captain is replaced by substitution or the Libero. The captain should acknowledge this designation by raising a hand. It is not necessary for the 2nd referee to repeat this procedure at the start of each set unless the game captain changes or the 1st referee requests the information.
13. **2nd referee “ready” signal:** Indicate by holding both hands in front of the body, just above head height, palms toward 1st referee. Used by a 2nd referee after any regular game interruption or a delay to the resumption of play. Also used by the scorer upon completion of recording a substitution(s), or at the end of a time-out. “Ready” means that the scorer has recorded all necessary information, the 2nd referee is in proper position, all players have taken their positions on the court, and the 2nd referee is ready for play to resume. The 1st referee is still obligated to complete a court scan, check that the server is in possession of the ball, and ensure team readiness before authorizing the next serve.
14. **Time-out administration:**
  - a. The 2nd referee has primary responsibility for whistling to acknowledge a time-out request; however, the 1st referee may assist by whistling if the 2nd referee does not quickly recognize the request. The referee who whistles the time-out will signal (Signal 4) with the vertical hand of the signal on the side of the requesting team and point toward the requesting team’s bench with an open hand. Only the referee who whistles to acknowledge the time-out request will show this signal; the other referee does not repeat the time-out signal unless it is necessary for clarification or communication purposes. The 2nd referee will informally display each team’s time-out status to 1st referee at the beginning of the time-out.
  - b. Players are not required to leave the court and go to the bench area. Coaches and non-playing team members may not enter the court.

- c. The 2nd referee whistles at the end of 30 seconds and ensures both teams re-take the court.
  - d. Upon conclusion of each team's second time-out, the 2nd referee notifies the coach (or captain, if necessary) by visually displaying the time-out signal (Signal 4) and then showing two fingers. The 2nd referee then notifies the 1st referee in the same manner, then returns to position for the resumption of play and signals "ready."
  - e. It is not necessary to notify teams after their first time-out unless requested to do so by the coach/captain. Similarly, the referees do not visually display each team's time-out status at the end of any time-outs unless necessary for clarification.
  - f. Teams may re-take the court prior to expiration of the time-out, unless it is necessary for the court to remain clear.
15. **Substitution procedure:** A request for substitution requires that the incoming substitute has entered the substitution zone before the request is acknowledged (whistled), except for a substitution related to an injury. Verbal or hand-signal requests for substitution by the coach or captain do not constitute a formal request and are not acknowledged (whistled).

NOTE: The 1st referee does not repeat the 2nd referee's signal for substitution unless it is necessary for clarification; however, if the 1st referee whistles to acknowledge a substitution request, he/she will show the substitution signal.

16. **Substitution notification:** With the ninth, 10th, 11th, and 12th team substitutions, the 2nd referee notifies the coach by displaying the substitution signal (Signal 5), followed by the number of team substitution used during the set (10 – clenched right fist, 11 – clenched right fist plus index finger of left hand, 12 – clenched right fist plus index and middle finger of left hand). The 2nd referee notifies the 1st referee of a team's 12th substitution in the same manner, then returns to position for the resumption of play and signals "ready." If requested by the 1st referee, the 2nd referee also informs the 1st referee of the ninth, 10th and 11th substitutions in this manner.
17. **Multiple substitutions by one team:** Only one incoming player may be in the substitution zone at a time awaiting authorization to enter. Subsequent substitutes must wait outside the substitution zone until the first pair of players has been authorized to enter by the 2nd referee. For multiple substitutions by a team during the same dead ball, there can be no significant delay between substitutions.

18. **Requests for game interruption by opponents during same dead ball:** When opponents request a time-out or substitution during the same dead-ball period, each team's request is acknowledged with a separate whistle. Multiple substitutions by the same team require only one whistle.
19. **1st/2nd referee duties:**
- The 1st referee controls the pre-match warm-ups with assistance from the 2nd referee who times the warm-up segments while the 1st referee tends to other pre-match duties.
  - Either referee may whistle net faults, and attack-hit or blocking faults.
  - The 2nd referee whistles antenna faults on his/her side of the court, including a served ball that has not been whistled by the 1st referee.
  - At the end of the match, the 1st referee checks the score sheet for accuracy, and then signs it.
20. **2nd referee discreet assistance techniques:** Discreet assistance from the 2nd referee should only be offered when, in the 2nd referee's opinion, a fault has occurred. Expectations regarding these techniques should be the subject of the referees' pre-match briefings. NOTE: Discreet signals, which are indicated using only one hand (ex: 2 hits, 4 hits, attack-hit fault, etc.) should be signaled with the hand corresponding to the team at fault. If the view of the 2nd referee is obstructed, the discreet signal may be made with the more visible hand.
- 2 hits vs. 4 hits: The 2nd referee should use the appropriate discreet assistance only after the same player has hit the ball twice in succession ("2 hits") or after a team has touched the ball four times and the third and fourth hits were not by the same player ("4 hits"). **NOTE:** "4 hits" should not be used to indicate "no touch" by the blocking team.
  - Attack-hit fault: The attack fault signal (Signal 21) should be shown in the chest area. Before whistling this fault, the 2nd referee should allow the 1st referee the opportunity to whistle the fault or to communicate that the play was legal (USAV 24.3.2.4).
  - Blocking fault: The 2nd referee may whistle this fault immediately, or a discreet blocking fault signal (Signal 12) may be shown in the chest area with hands only, shoulder-height.
  - Requesting an individual sanction: The 2nd referee should whistle, step to the offending team's side of the court, and verbalize the



sanction and offending team member. Other hand signals are not necessary to request an individual sanction.

- e. Requesting a delay sanction: Display the delay sanction signal, without a card in chest area.
  - f. Ball in/pancake play: Step to the side of the court where the ball hit the floor, maintain a position visible to the 1st referee, and give the “ball in” signal. If the 1st referee does not see this assistance, the signal should be made more visible. If the 1st referee does not quickly recognize the assistance, the 2nd referee should whistle this fault.
  - g. Ball handling opinions: The 2nd referee should not offer ball handling opinions during a match. Only if the 1st referee has requested such assistance during unusual plays (i.e., the 1st referee is screened from viewing the play) should the 2nd referee offer an opinion.
  - h. Touch information: At the end of a rally in which the 2nd referee has observed a player touching the ball before it lands out of bounds, and the 2nd referee believes the 1st referee has not seen the touch, the 2nd referee should offer a visible “touch” signal (Signal 24). If the 1st referee does not notice this assistance, the signal should quickly be made more visible and the 2nd referee should step laterally, away from the post.
21. **Deciding set coin toss:** For the deciding set coin toss, the 2nd referee conducts the coin toss near the scorer’s table. During this time, teams are released to their benches while each team’s game captain attends the toss. The coin toss takes place during the three-minute interval between sets. The referee holds the coin above the head and whistles to call the captains to the toss. After the coin toss, the 2nd referee notifies the 1st referee of the result and directs the teams, without whistling, to change courts or to remain at their current benches for the start of the deciding set. The scorer is immediately notified of the result in order to prepare the deciding set score sheet; and, if the 1st referee conducted the toss, he/she immediately returns to the stand.
22. **Change of courts:** See USAV 18.2. The default protocol is for teams to remain on the same side of the court for the duration of the match. The protocol of changing courts between sets and at the 8th point in a deciding set is still an option, at the discretion of the event organizer.

23. **Change of courts** during the deciding set (when applicable): The 1st referee signals for teams to change courts immediately after the eighth point has been scored by a team. Teams are not directed to the end lines during this court change, but they should change sides by going counterclockwise around the post to their respective right side (or under the net near the sideline if space does not permit the players to pass outside the posts). To prevent teams from crossing under the net in the middle of the court, the 2nd referee enters the court to his/her right and directs the team on the right to change sides as described above. The 2nd referee also ensures the team on the left changes sides accordingly. The 2nd referee returns to the scorer's table after the court change to ensure the scorer is ready to resume. The 2nd referee and scorer should confirm each team's court positions before continuing.
24. **Set/Match point:** The 2nd referee verbally/visually confirms set or match point with the scorer and then places an index finger against the shoulder corresponding to that team. For example, if the team to the 2nd referee's left has earned set/match point, the index finger of the right hand is placed against the left shoulder (or vice versa for the team on the right).
25. **Ball hitting an antenna:** When the ball is hit into an antenna, the referee whistles and signals "out," and if necessary, indicates with an open hand the player who hit the ball into the antenna. The referee does not point toward the antenna before or after signaling "out" for the antenna fault. If the 1st referee whistles the antenna fault, he/she first shows the team to serve next before signaling the antenna fault.
26. **1st referee whistling positional faults on receiving team:** The 1st referee normally checks position faults for the serving team only; the 2nd referee is authorized to check position faults for receiving team only. If the 2nd referee does not call a blatant positional fault after ample communication/notification by the 1st referee, the 1st referee may whistle this fault. This occurs only on very rare occasions.
27. **Sanction procedures:** Referees must recognize the difference between emotions or reactions during competition and conscious decisions or actions that result in unsporting conduct.
  - a. For a player on court: The 1st referee directs the player being sanctioned to approach the 1st referee's stand to acknowledge the sanction. The 1st referee displays the appropriate card(s) to the sanctioned player and verbalizes, "This [warning (yellow card), penalty, expulsion or disqualification] is for your unsporting

conduct.” If the sanction is a penalty (red card), the 1st referee then signals to award a point to the opponent and ensures the 2nd referee and scorer are aware of the penalty point.

- b. For a team member on the bench: The 1st referee whistles to call the game captain to the stand and then displays the appropriate card(s) and verbalizes, “This [warning (yellow card), penalty, expulsion or disqualification] is for player (or coach) ‘X’. Please inform him/her of the [sanction].” The captain must go immediately to the bench to inform the team member, who acknowledges the [sanction] while the 1st referee displays the appropriate card(s). If the sanction is a penalty (red card), the 1st referee then signals to award a point to the opponent and ensures the 2nd referee and scorer are aware of the penalty point.
  - c. For delay sanctions: The 1st referee calls the game captain to the stand and verbalizes, “This delay sanction is for [delay action],” while displaying the appropriate signal. The captain may inform the coach of the sanction for clarification purposes. If the sanction is a delay penalty, the 1st referee then signals to award a point to the opponent and ensures the 2nd referee and scorer are aware of the penalty point.
  - d. For verbal warnings: Verbal warnings must be accompanied by a whistle and are issued through the game captain. Multiple warnings to the same team member during the same set/match are permitted for minor unsporting conduct.
  - e. For simultaneous sanctions to opponents: When individual sanctions are assessed to opponents for simultaneous unsporting acts, the team member from the serving team is sanctioned first, followed by the team member from the receiving team.
28. **Notification of illegal Libero replacement:** The assistant scorer notifies the 2nd referee of an illegal Libero replacement before the contact of the serve. The replacement is corrected and a delay warning (or penalty) sanction is the resulting sanction.
29. **Line judge position during time-outs:** At midpoint of respective end line.
30. **Line judge position when server is within 1-2 meters of the line judge:** When a server takes a position within 1-2 meters of the line judge, the line judge must step away from the server along the imaginary extension of the end line. After the service contact, the line judge should quickly return to the position at the intersection of the end line and sideline.

## REFEREE POINTS OF EMPHASIS

1. **Warm-ups:**
  - a. For adult competition: When one team has exclusive use of the court, the opposing team may warm up with practice balls in the free zone surrounding the court but may not interfere with the warm-up of the opponent on the court, including serving practice.
  - b. For junior competition: When one team has exclusive use of the court, the other team must either be at its team bench or out of the playing area. The team may also retrieve balls for the opposing team. Warming up with balls at the team bench or in the spectator walkways is not permitted.
2. **The Serve:** Both of the server's feet must be in contact with the playing surface before the serve is authorized. If this is not the case, the 1st referee will direct the player onto the playing surface before authorizing the serve. Part of the server's foot/feet may be in contact with the secondary surface/non-playing area. It is a fault when a server steps completely off the playing surface after the authorization to serve.
3. **Coaches' Location:** During the match, the coach may give instructions to players on the court while standing or walking within the free zone in front of his/her team's bench from the extension of the attack line up to and including the warm-up area, without disturbing or delaying the match. The coach must not obstruct the view of the line judges. If a coach continues to encroach the line judge's position after being reminded to provide sufficient space for the line judge, a delay sanction may be assessed.

NOTE: Coaches may not enter the substitution zone or service zone. The coach and/or one assistant coach may give instructions to a player in the warm-up area.

4. **Assistant Coaches:** One assistant coach at a time may leave the bench to give instructions to the players on the court. During play, this assistant coach may give these instructions while standing or walking within the free zone in front of his/her team's bench from the extension of the attack line up to and including the warm-up area, without disturbing or delaying the match. Assistant coaches may not address the referees and must not obstruct the view of the line judges.
5. **Disruptive Coaching:** Includes loud or abusive language; comments to officials or to opposing teams; throwing of objects; attempting to

influence an official's decisions (Rule 20.1.3); and, displaying disgust in an overt manner.

**6. The Libero:**

- a. Up to two Liberos may be designated on the line-up sheet at the start of the match. If zero or one Libero is designated on the line-up sheet, the coach may select a different Libero for subsequent sets but may not have two Liberos. If two Liberos are designated on the line-up sheet for Set 1, those are the only two Liberos who may play for that team for the match.
- b. The Libero's jersey or jacket must clearly contrast in color to the color of the jersey worn by other members of the team. (See USAV 19.2a.) The Libero jerseys do not have to match, but they must both be contrasting from the other members of the team. "Contrast" means "strikingly different." As such, two dark colors (or two light colors) often do not provide sufficient contrast from one another.
- c. If a Libero wears an exposed undergarment as noted in USAV 4.3, that undergarment may differ from exposed undergarments worn by teammates.
- d. A Libero may replace an injured player in the back row if no Libero was on the court at the time of the injury.
- e. Only one Libero per team may be on the court in replacement of a teammate at any given time.

**7. Player Equipment:**

- a. If a player's towel or other equipment falls to the floor during a rally, which consequently requires a stoppage of play, a delay sanction must be issued. The rally should not be stopped unless a referee judges that a safety hazard exists. A delay sanction can be avoided if the team takes steps to mitigate the risk hazard in this situation.
- b. Player equipment (eyeglasses, contact lenses, etc.) is worn at the player's own risk (Rule 4.5.2). If a stoppage of play results due to a concern for safety, a delay sanction is assessed, and a replay will be granted. A similar rationale, as noted above in 7a, should be used to determine if a safety hazard exists. If a player is injured as his/her lenses fall to the floor, the injury takes precedence and the provisions of Rule 17.1 should be applied.
- c. Casts are not permitted, regardless of covering or padding.

- d. Bobby pins, barrettes and hard plastic headbands may be used to control the hair. Such items do not need to be covered or padded.
- e. Jewelry may be worn provided its nature does not present a concern for safety, such as extremely long necklaces and/or necklaces with large medallions, or large hoop earrings.
- f. Head coverings. A waiver for a head covering worn for medical, religious, or cultural purposes is not required and need not be requested by tournament staff or referees. Hats of any style are not permitted.
- g. Compression pads or sleeves are personal equipment and are not considered part of the uniform. The color of the pads or sleeves may vary from player to player and does not need to match the team uniform color(s).
- h. A guard or brace, or headgear, are permitted; padding or a covering may be necessary. A prosthetic limb(s) is permitted; sharp edges may need to be wrapped or padded to ensure safety.

**8. Interference with Play:**

- a. A player who places a hand/hands near the net in the path of a ball to deflect the natural rebound of a ball that has been passed into the net by the opponent has committed a net fault according to the FIVB/USAV interpretation of “interferes with play.” (Rule 11.4.4)
- b. If a player contacts an official (2nd referee or line judge) during an attempt to play the ball legally, the 1st referee may award a replay if the physical interference impeded that player’s attempt.
- c. A ball that contacts an official (referee or line judge) is ruled “out” per Rule 8.4.2.
- d. A player may not interfere with an opponent who is making an attempt to legally play the ball, including in the free zone. Contact, the anticipation of contact, or physical or verbal distractions by the opponent may constitute interference.

**9. Improper Requests (See also Referee Techniques #8):**

- a. A request for an illegal substitution shall result in an improper request. However, if such a request is acknowledged (i.e., whistled), a delay sanction shall result.

- b. Despite any previous delay sanction, a team's first improper request of the match is rejected, and the improper request is assessed without further sanction.
10. **Line-up Checks:** A line-up check is not considered a regular game interruption and is permitted prior to re-authorizing the serve for a rally that was not completed. A line-up check may not be requested after the service authorization, and before the service contact, even if the 1st referee must authorize the serve a second time due to external interference (e.g., a ball on the court). Coaches or captains may request a line-up check.
  11. **Line Judge Duties:** Per Rule 27.2.1.6, a line judge may signal when a player touches the top 80cm (32") of an antenna during the action of playing the ball (Line Judge Signal 5).

## BASIC MATCH PROCEDURES FOR REFEREES

The following are basic officiating procedures for conducting USA Volleyball matches.

### 1. OFFICIALS

- a. The officials should be certified USA Volleyball referees and qualified or certified USA Volleyball scorers.
- b. The prescribed USA Volleyball uniform and certification patch should be worn by all referees.
- c. At a minimum, referee equipment includes a whistle with lanyard, a set of yellow/red cards, a flipping coin and a watch or timing device.

### 2. ARRIVAL

- a. Referees should arrive at the playing venue no less than 30 minutes prior to the start of the competition.
- b. The tournament director or event manager should be located at that time, and playing formats, ground rules, warm-up procedures and other protocols should be determined.

### 3. MATCH PREPARATION

- a. Referees or scorers should examine the court and playing equipment prior to the first match: identify court lines, playing area, and any floor obstructions; determine rulings for overhead obstructions; examine the playing equipment (including net, antennae, posts, referee stand and game balls); and verify the net height and ball pressure.
- b. Referees or scorers should ensure pens, pencils, score sheets and Libero Control Sheets are available at the score table. Line-up sheets and rosters may also be required.

### 4. REFEREES' PRE-MATCH DUTIES

- a. Prior to the coin toss, the 1st and 2nd referees must discuss their match responsibilities, as well as communication techniques that will be used between them during the match. This should include, among other things: discreet signals from the 2nd referee; addressing conduct issues; and ensuring consistent application of ground rules.
- b. Preferably prior to the coin toss, or immediately thereafter, the referees will meet with the officiating crew to give instructions to the line judges (1st referee) and scoring crew (1st or 2nd referee).



- c. Conduct a coin toss between the team captains prior to the start of the timed warm-up period. Once tossed, the coin is caught, and the result immediately revealed.
- d. After the coin toss, the 1st referee will supervise warm-up periods and may request the 2nd referee to time their duration. NOTE: In the event team does not choose to use its time on the court, the court shall remain unoccupied.
- e. During the warm-up period, the 1st referee must verify the legality of each team's player and Libero uniforms. All players must wear uniforms as prescribed in Rule 4.3 and/or Rule 19.2 and USAV Rule 19.2.
- f. The 1st or 2nd referee will blow a whistle to indicate the end of the warm-up period and that players are to clear the court.
- g. Referees and other officials take their assigned places.

**5. START OF THE FIRST SET OF THE MATCH**

- a. Teams line up on the end line of their respective team courts. When both teams are ready, the 1st referee will blow a whistle and motion for players to take their positions on their court. Teams often greet each other at the net prior to taking their court positions.
- b. The 2nd referee, using each team's submitted line-up sheet, the scorer using the score sheet, and the assistant scorer using the Libero Control Sheet, will verify that players are in the correct positions on the court. Prior to the start of play, changes and/or substitutions can be made under the provisions of Rules 4.1.3, 7.3.2, 7.3.4 and USAV 7.3.4. NOTE: A substitution prior to the start of any set is permitted.
- c. Upon completing the line-up check, the 2nd referee will permit Libero replacements to occur and confirm that the assistant scorer has recorded them.
- d. The 2nd referee then retrieves the game ball from the score table and delivers it to the first server of the match. The 2nd referee will then take a position on the receiving team's side of the net and indicate "ready" to the 1st referee. The 1st referee whistles and beckons for the first service of the set. This marks the time the set officially begins.
- e. Prior to the contact of the serve, serving team players should be in their correct positions on the court, with no distracting movements.

Continual or distracting movement may be construed as screening. The 1st referee must be aware of screening during all service actions.

## 6. DURING THE MATCH

- a. Each referee has specific duties and responsibilities during the match as outlined in Rules 23 and 24.
- b. Judgment and ball handling decisions, as well as match control, flow and tempo, are very important for any 1st referee.
- c. Match administration (substitutions, time-outs, etc.), communication with the team benches and score table, and positioning/focus during net play are important aspects of working as a 2nd referee.
- d. Scorer, assistant scorer and line judge duties are clarified in Rules 25, 26 and 27.

## 7. PROCEDURES FOR REGULAR GAME INTERRUPTIONS

- a. Substitutes enter the substitution zone and wait for the 2nd referee to acknowledge the request and authorize the substitute to enter the court. Only the referee who whistles the substitution request will show the substitution signal, unless repeating the signal is necessary for clarification. Entry into the substitution zone is the only legal request for a substitution, except for injury situations or substitutions prior to the start of a set. For multiple substitutions by the same team during one dead ball period, each substitute must enter the substitution zone in succession, one pair at a time, and must wait until entry is authorized by the 2nd referee. There can be no delay between incoming substitutes. When opponents request substitutions simultaneously, the 2nd referee asks one team wait while the other team's substitution is administered and recorded. After this substitution has been recorded, the 2nd referee will whistle to recognize the substitution for the other team and then authorize the substitute to enter the game.
- b. When the coach or game captain requests a time-out, the 2nd (or 1st) referee should immediately whistle, show Signal 4, Time-out, and then indicate the team by pointing, open-handed, toward that team's bench. Only the referee who whistles the time-out request will show the time-out signal. The 2nd referee will then visually inform the 1st referee of the number of time-outs each team has taken. After 30 seconds have elapsed, the 2nd (or 1st) referee must whistle to end the time-out. Teams should immediately retake the

court. The 2nd referee verbally and visually notifies each team's coach, and visually notifies the 1st referee, only when that team's second time-out has been taken. The 1st referee prepares for the next rally.

## 8. END OF THE SET AND START OF THE NEXT SET

- a. A set officially ends when the whistle is blown for the fault resulting in the winning point. The set interval begins when the 1st referee executes Signal 9, End of Set. Following the whistle that indicates the end of a set, the 1st referee will direct the teams to return to their bench; see USAV 18.2.

OPTION: If teams will change playing areas and benches between sets, the change takes place immediately, with the exception of the interval before the deciding set. For a change of courts (except the deciding set), the players proceed to their right until they reach their new bench area with the team on the left passing behind, or if court space is limited, directly in front of, the 1st referee and proceeding to the bench. Team personnel and substitutes change playing areas in front of the score table.

- b. The 2nd referee will collect the line-ups from both teams as quickly as possible during the set interval; however, line-ups must be submitted no later than 2:30 during the set interval. With 30 seconds remaining in the interval, the 2nd referee will blow a whistle and teams shall immediately report to the court and line up in their proper positions to start the set.
- c. When a deciding set will be necessary, and teams will change courts, the teams follow a different procedure at the end of the set prior to the deciding set. Following the whistle indicating the end of the set, the 1st referee will release the teams to their respective benches. Each team's captain immediately meets at the score table where the 2nd (or 1st) referee will conduct the coin toss for the deciding set. The coin toss takes place during the three-minute interval. Once the choice of sides has been determined, the referees, without whistling, direct the teams to their appropriate team areas. The procedure for the start of the deciding set is the same as stated in 8b.

NOTE: The default protocol is for teams to not change courts between sets or during a deciding set. For the deciding set, the winner of the coin toss will choose to serve or receive the serve; each team will remain on the side they currently occupy.

## 9. CHANGE OF TEAM AREAS DURING A DECIDING SET

- a. NOTE: The default protocol is for teams to not change courts/benches/team areas during the deciding set. If the alternate protocol will be used, the following procedures apply:
- b. When teams change team areas during a deciding set of a match (Rule 18.2 & USAV 6.3.2), the 1st referee will blow a whistle and show Signal 3, Change of Courts. Teams will change playing areas as noted in 8a above, without delay and with player positions remaining the same.
- c. Substitutes and other team personnel will change team areas in front of the score table.
- d. The 2nd referee and scorer will quickly verify that players are in their correct positions on the court.

## 10. AT THE END OF THE MATCH

- a. Following the whistle indicating the last rally of a match, the 1st referee will whistle again and display Signal 9, End of Match.
- b. At nationally sanctioned competitions after displaying the end of match signal, the 1st referee steps down and stands to the right (Team A side) of the stand. The 2nd referee crosses the court and stands to the left of the stand (Team B side). The 1st referee will then whistle and direct teams to shake hands at the net. The teams may shake the referees' hands as well.

NOTE: Alternatively, for non-national competitions, after the 1st referee has whistled and signaled the end of the match (10a above), the 1st referee will blow a final whistle and motion for the teams to proceed to the center of the court to shake hands with the opponents. The post-match handshake at the center of the court may be modified: teams may acknowledge one another by waving.

- c. The 2nd referee will ensure that the game ball is returned to the score table.
- d. Both team captains shall thank the referees.
- e. The 1st referee will then review the score sheet to verify the final results and ensure the scorer has signed the sheet. The 1st referee will then sign the score sheet(s).
- f. Referees will then immediately depart the playing area.

## 11. PROTEST PROCEDURES (USAV 5.1.2.1)

- a. Protestable situations now include a scoring discrepancy.
- b. The coach may handle the protest procedure for any age level; the team or game captain is encouraged to participate for educational purposes
- c. A protest must be lodged immediately at the end of the rally in which the protested situation occurred; a serve negates a protest of any previous rally.
- d. The last rally of a set/match must be protested within 60 seconds of the end of that set/match.
- e. The coach may not cross the court to speak with the 1st referee; the 1st referee may leave the stand, if necessary, to confer near the team bench and consult the rules book to resolve the protest.
- f. Judgment decisions are not protestable. A penalty (red card) may be assessed at the direction of the tournament staff or head referee for a protest related to a judgment decision.
- g. For tournaments with a Protest Committee:
  - Referee(s) stay at the court; send responsible work team member to tournament staff.
  - Referees wait on their respective side of the court; no discussion among referees or with any coach, team member, work team crew, or spectator.
  - Coach and player behavior are still subject to sanction.
  - 1st referee informs Protest Committee which team lodged the protest and then speaks with that coach and/or captain.
  - Protest Committee may request a conduct sanction during this time if behavior is unsporting; the sanction is assessed prior to the next serve at the conclusion of protest proceedings.
  - Protest Committee may approach any member of the officiating team to collect facts to make a ruling.
  - Protest Committee informs both teams of the decision and may assist with preparing the teams and court to resume play.
  - The coach may discuss the decision or ruling with the Protest Committee after the match.





---

SECTION VI

---

**USAV SCORING  
INSTRUCTIONS &  
SCORE SHEETS**

# Diagram 1

## NON-DECIDING SET SCORE SHEET



### OFFICIAL SCORESHEET

One-Set ScoreSheet

Name of the competition:	
City, State:	Pool Phase:
Hall:	Match N°:
Division: Men <input type="checkbox"/> Women <input type="checkbox"/> Coed <input type="checkbox"/>	Level:
Category: Adult <input type="checkbox"/> Junior <input type="checkbox"/>	vs

8:00 = 08:00  
 9:00 = 14:00  
 2:00 = 14:00  
 3:00 = 15:00

Date	
Court	
Time	

D-Delay: A-Assist Coach | B-Proper Request  
 E-Player Manager | TEAM ① : TEAM ②  
 C-Server | S-Setter | SET SCORE

REMARKS

TEAM	MATCH WINNER	Sets	W	L
TEAM	SET RESULTS	Score		
Winning				
Losing				

Scorer \_\_\_\_\_ SIGNATURES  
 Ist Referee \_\_\_\_\_

Officials PRINTED NAMES  
 Ist \_\_\_\_\_  
 2nd \_\_\_\_\_  
 Scorer \_\_\_\_\_  
 Work Team \_\_\_\_\_  
 Region \_\_\_\_\_

Substitutions: 1 2 3 4 5 6 7 8 9 10 11 12

Set	CAPTAIN						Points	Time Outs	CAPTAIN						Points	Time Outs	Set								
	Team	Liberal	A	B	C	S			Team	Liberal	A	B	C	S											
I	II	III	IV	V	VI	1 13 25	1 13 25	I	II	III	IV	V	VI	1 13 25	1 13 25	End									
:	:	:	:	:	:	2 14 26	2 14 26	:	:	:	:	:	:	2 14 26	2 14 26	:									
:	:	:	:	:	:	3 15 27	3 15 27	:	:	:	:	:	:	3 15 27	3 15 27	:									
:	:	:	:	:	:	4 16 28	4 16 28	:	:	:	:	:	:	4 16 28	4 16 28	:									
:	:	:	:	:	:	5 17 29	5 17 29	:	:	:	:	:	:	5 17 29	5 17 29	:									
:	:	:	:	:	:	6 18 30	6 18 30	:	:	:	:	:	:	6 18 30	6 18 30	:									
:	:	:	:	:	:	7 19 31	7 19 31	:	:	:	:	:	:	7 19 31	7 19 31	:									
:	:	:	:	:	:	8 20 32	8 20 32	:	:	:	:	:	:	8 20 32	8 20 32	:									
:	:	:	:	:	:	9 21 33	9 21 33	:	:	:	:	:	:	9 21 33	9 21 33	:									
:	:	:	:	:	:	10 22 34	10 22 34	:	:	:	:	:	:	10 22 34	10 22 34	:									
:	:	:	:	:	:	11 23 35	11 23 35	:	:	:	:	:	:	11 23 35	11 23 35	:									
:	:	:	:	:	:	12 24 36	12 24 36	:	:	:	:	:	:	12 24 36	12 24 36	:									
:	:	:	:	:	:			:	:	:	:	:	:			:									
Substitutions:	1	2	3	4	5	6	7	8	9	10	11	12	Substitutions:	1	2	3	4	5	6	7	8	9	10	11	12



# GENERAL SCORING PROCEDURES

## S1 GENERAL PROCEDURES

### S1.1 RECORDING INFORMATION

- S1.1.1 The scorer clearly records all information (except the signatures) using PRINTED CAPITAL letters on the score sheet.
- S1.1.2 Some information must be recorded **using blue/black ink**. The instructions will indicate if blue/black ink is required.
- S1.1.3 Other information may be recorded using either pencil or blue/black ink.
- S1.1.4 National Scorers: Must record all information **using blue/black ink**.

### S1.2 INCORRECT INFORMATION

- S1.2.1 Incorrect information must be corrected immediately.
- S1.2.2 Remove the incorrect information by:
  - Use of correction tape
  - Use of an eraser
  - Crossing out information using an **X**.

### S1.3 DATES

All dates are recorded using **MM/DD/YY** or **MM-DD-YY** with leading zeros as necessary.

**Examples:** 06/02/15 06-02-15

### S1.4 TIMES

All times are recorded using International Time **HH:MM** with leading zeros as necessary.

**Examples:** 9:10AM=09:10 1:15PM=13:15

### S1.5 SCORES

When an action requires recording both team scores (time-outs, substitutions, sanctions, remarks), record the score of the team causing the action first.

**Example:** Team A score 5 and Team B score 10 when Team B takes a time out. Record **10:5** as score.

## S1.6 PENALTY POINTS

S1.6.1 Slash the point in the **POINTS** column.

S1.6.2 Draw a circle around the slashed point.

## S1.7 AUTOMATIC THREE (3) SET MATCHES

Some events use a best-of-three sets match format with some matches designated to play all 3 sets (**automatic three (3) set match**).

S1.7.1 If a coin toss and court change is required for set 3:

A deciding set score sheet is used;

The scoring procedures are the same as for any deciding set.

S1.7.2 If no coin toss or court change is required for set 3:

A regular score sheet is used;

The scoring procedures are the same as for any non-deciding set.

## S1.8 READY SIGNAL

S1.8.1 When ready for the set to continue:

Make eye contact with 2nd referee;

Raise both hands, palms facing forward.

## S2 PRE-MATCH

### S2.1 BEFORE THE START OF A MATCH

S2.1.1 Prepare all the score sheet(s) for the match by recording the match information for:

Sets 1 and 2 for a best-of-three match;

Sets 1 through 3 for an 'automatic 3-set match';

Sets 1 through 3 for a best-of-five match.

### S2.2 HEADINGS

Use blue/black ink.

If the heading information is not pre-printed, record the following information:

S2.2.1 **Name of Competition**

S2.2.2 **City, State**

S2.2.3 **Hall NAME OF FACILITY**

S2.2.4 **Pool Phase**

For **Pools**, use number or letter  
For **Phase**, use playoff bracket (e.g. GOLD, SILVER, BRONZE, etc.)

S2.2.5 **Division** X the appropriate box

S2.2.6 **Match No.** number or SEMI, FINAL, etc.

S2.2.7 **Category** X the appropriate box

S2.2.8 **Level** Record the level of play (AA, A, 40s, 16O, or other description)

S2.2.9 vs Record the complete names of the playing teams for the match;  
TEAM NAME vs TEAM NAME  
In the upper right-hand corner

S2.2.10 **Date** Match Date

S2.2.11 **Court** Court Number

S2.2.12 **Time** Scheduled Match Time  
Leave blank if the scheduled time is based solely on the previous match's end time.

### S2.3 OFFICIALS PRINTED NAMES

Use blue/black ink.

Record all officials' names as LAST NAME, FIRST NAME.

S2.3.1 1st Name of First Referee

S2.3.2 2nd Name of Second Referee

S2.3.3 Scorer Name of Scorer

S2.3.4 Work Team WORK TEAM NAME

S2.3.5 **Region** Region code of work team (2-character code)

### S2.4 SET NUMBER

Use blue/black ink.

If not pre-printed, record the set number in the Set box.

### S2.5 SET WITH SCORE NOT STARTING AT 0-0

Use blue/black ink.

For any set not starting at 0-0, record the unused points with the T-Bar method as follows: **Set starts at 4-4**

- S2.5.1 Draw a horizontal line below the last unused number in the **Points** column.
- S2.5.2 Draw a vertical line from the top of the **Points** column to the horizontal line.

Points	Points
1 13 25	1 13 25
2 14 26	2 14 26
3 15 27	3 15 27
4 16 28	4 16 28
5 17 29	5 17 29

### S3 STARTING THE MATCH

#### S3.1 TEAM DESIGNATION

After the coin toss and the determination of the serving team and the playing area.

- S3.1.1 Designate the team that begins Set 1 on the **left** court as Team **A**.
- S3.1.2 Designate the team that begins Set 1 on the **right** court as Team **B**.
- S3.1.3 Each team keeps the **A/B** letter designation assigned in Set 1 for the entire match.

#### S3.2 TEAM INFORMATION

Use **blue/black ink**.

- S3.2.1 **For Set 1**, in the **TEAM INFO** section:
- Record Team A's name (shorten as needed) in the Team box on the left side.
    - If not pre-printed, record an A in the A/B circle on the left side.
  - Record Team B's name (shorten as needed) in the Team box on the right side.
  - If not pre-printed, record a B in the A/B circle on the right side.
- S3.2.2 For the remaining non-deciding Sets, in the **TEAM INFO** section:
- Teams will change courts for each non-deciding set
  - Record Team Information on the opposite sides from the previous set score sheet.

For Set 2:

- 1) Record Team B information on the left side.
  - 2) Record Team A information on the right side.
- c. Alternate for each remaining non-deciding set score sheet.

### S3.3 SERVING AND RECEIVING TEAMS

Use blue/black ink.

S3.3.1 For the team serving first:

- a. Record an X through the Ⓢ.

S3.3.2 For the team receiving first:

- a. Record an X through the Ⓡ.
- b. Record an X in box 1 of the SERVICE ROUNDS section for the player in SERVICE ORDER I.

S3.3.3 Repeat S3.3 on all non-deciding score sheets. Serve and receive will remain on the same court (side).

### S3.4 ROSTERS (IF REQUIRED BY EVENT)

**Rosters may not be used by all events.**

S3.4.1 Obtain an official roster from each team.

S3.4.2 Verify player uniform numbers are correct and accurate.

S3.4.3 Once submitted, no roster changes are permitted unless approved by event management.

S3.4.4 Roster changes may result in team penalties as directed by event management.

### S3.5 TEAM CAPTAINS (FROM ROSTERS)

Use blue/black ink.

S3.5.1 No Rosters, record an X in the **Captain** box.

S3.5.2 Rosters with no designated team captain, record an X in the **Captain** box.

EXAMPLE: No rosters or no Team Captain designated.



S3.5.3 Rosters with a designated team captain, record the team captain's number in the Captain box.

EXAMPLE: 8 is the roster Team Captain

This player is always the captain when on the court.



### S3.6 LINE-UP SHEETS

S3.6.1 Obtain a **LINE-UP** sheet from each team (previously distributed to each team).

S3.6.2 Opponents may not see the other team's **LINE-UP** sheet after it has been obtained.

S3.6.3 Verify that a coach or team captain has signed each **LINE-UP** sheet.

S3.6.4 Verify that Libero designations have been indicated.

S3.6.5 Verify that a game captain is indicated using a "C" next to the player number.

- a. If the roster team captain starts the set, he/she must be the game captain.
- b. **[Optional]** An alternate captain may be designated on the line-up sheet using an "A" next to the player number.

S3.6.6 Verify that there are no duplicate numbers among the starting player, including the Libero(s)

S3.6.7 Immediately return an incomplete or inaccurate line-up sheet to the 2nd referee.

### S3.7 LIBERO DESIGNATION

#### Use blue/black ink.

S3.7.1 A Libero may be the team, game or alternate captain.

S3.7.2 At the start of the match, each team must decide whether to designate two (2) Liberos for the match or zero (0) or one (1) Libero per set. This decision must be indicated on the **LINE-UP** sheet for Set 1.

S3.7.3 **Zero (0) or one (1) Libero** is designated on the **LINE-UP** sheet for Set 1:

- a. The empty Libero box(es) for Set 1 must contain an **X**.
- b. All remaining sets may have a maximum of one (1) Libero designated.
- c. The Libero may be a different player for each set.
- d. Record an **X** in the second Libero Box (R) on the remaining sets **LINE-UP** sheets.
- e. Record an **X** in the second Libero Box (R) in the **TEAM INFO** section for this team on all non-deciding set score sheets.

S3.7.4 **Two (2) Liberors** are designated on the **LINE-UP** sheet for Set 1:

- a. The Liberors must be the same for all sets
  - 1) Unless a Libero re-designation has occurred.
- b. Record the two Libero numbers in Libero Boxes on the remaining sets **LINE-UP** sheets.
- c. Record the two Libero numbers in the Libero boxes in the **TEAM INFO** section for this team on all non-deciding set score sheets.

### S3.8 VERIFYING LINE-UP PLAYER NUMBERS

- S3.8.1 No changes to player numbers may be made after the **LINE-UP** sheet has been submitted, except to correct a duplicate number prior to the start of a set.
- S3.8.2 Substitutions may be made prior to the start of any set.
- S3.8.3 If rosters are used, verify the numbers on the **LINE-UP** sheet are consistent with the numbers on the roster.

### S3.9 RECORDING THE GAME CAPTAIN(S)

#### **Use blue/black ink.**

- S3.9.1 Record the game captain's number in the **CAPTAIN** circle. The game captain is designated on the **LINE-UP** sheet by a "C."
- a. If the game captain leaves:
    - 1) An alternate captain must be designated.
  - b. If the game captain returns:
    - 2) He/she will resume the duties of captain.
- S3.9.2 If an alternate captain has been designated on the **LINE-UP** sheet using an a, record the alternate captain in the first available slot in

the CAPTAIN section

**COBRAS Team A; Receiving; No Rosters; Libero 8 captain; 10 alternate captain;** Libero 8 is game captain when on the court; 10 is game captain when 8 is off the court.

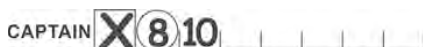

### S3.10 RECORDING THE LINE-UPS

Use blue/black ink.

S3.10.1 Record the starting players' uniform numbers in position order in the SERVICE ORDER section.

- Record the numbers in the middle of the top line of each box.
- Match the Roman numeral box on the **LINE-UP** sheet to the corresponding Roman numeral on the score sheet. Do this for both teams regardless of which team is serving first.

Order	I	II	III	IV	V	VI
	15	11	10	47	23	2

### S3.11 CHECKING PLAYERS ON THE COURT

Verify the players on the court, using the **SERVICE ORDER** section of the score sheet, as the 2nd referee checks the player's starting position on the court using the **LINE-UP** sheet.

- Confirm the correct player numbers are on the court.
- Confirm the player numbers are in the correct starting positions according to the service order.
- Notify the 2nd referee of any discrepancies in either player numbers or starting positions.

IV	III	II	V	VI	I
47	10a	11	23	2	15

### S3.12 LEGAL SUBSTITUTES SECTION

Use blue/black ink.

- National Scorers: Must record information about available substitutes in the **Legal Substitutes** section.
- The Liberos are not **Legal Substitutes**.



S3.12.3 [Optional] If rosters are provided, record the non-starting players on the roster in the **Legal Substitutes** section.

S3.12.4 [Optional] If there are no available substitutes, record “NO SUBS” in the **Legal Substitutes** section.

### S3.13 START TIME

Use **blue/black ink**.

Record the start time (using international format) in the **START TIME** box when the 1st referee whistles for the first serve. (Samples are provided in upper right section of the score sheet.)

CAPTAIN X 8 10			
Start	09:00	Team	
		COBRAS	
Order	I	II	III
	15	11	10

## S4 RECORDING INFORMATION

### S4.1 INFORMATION DURING THE SET

S4.1.1 Record using either pencil or **blue/black ink**.

## S5 CONTROLLING SERVICE

### S5.1 VERIFYING CORRECT SERVER

Verify the correct server has the ball and is preparing to serve each time a player enters the service zone.

## S6 RECORDING SERVICE AND RESULT

### S6.1 SERVICE ROUNDS BOX

S6.1.1 Use one box for the entire term of service for each position, whether the player serves once or multiple times.

S6.1.2 The first time the correct server serves in a particular service round, record a small checkmark (✓) through the number in the corner of the appropriate **SERVICE ROUNDS** box beneath the serving player's number.

S6.1.3 When the serving team wins the rally:

- Record by slashing the appropriate point in the **POINTS COLUMN** for the serving team.

S6.1.4 When the receiving team wins the rally:

- a. Record the exit score in the checked **SERVICE ROUNDS** box.
  - 1) The exit score is the serving team's total cumulative points.



Points	
✓ 13	25
✓ 14	26
3 15	27



- b. Immediately record the rally point for the receiving team by slashing the appropriate point in that team's **POINTS COLUMN**.
  - 1) The slashed rally point is 1 point more than that team's previous exit score, unless points have been removed due to a fault.

## S6.2 LIBERO SERVING

A Libero is permitted to serve in only one rotational position during each set. When two Liberos are used by a team, either/both Liberos may serve but both must serve in the same rotational position.

S6.2.1 Record this position by drawing a triangle around the **Service Order** Roman numeral the first time a Libero serves in the set.

S6.2.2 When the serving team wins the rally on a Libero's serve:

- a. Draw a triangle around the appropriate point(s) in the **POINTS COLUMN**.

Start	Team	Libero			
:	<b>BLUE</b>	8	X	A	A
I	II	III	IV	V	VI
2	16	5	10	7	4

S6.2.3 When the receiving team wins the rally,

- a. Record the exit score in the checked **SERVICE ROUNDS** box.
- b. Immediately record the rally point for the receiving team by slashing the appropriate point in that team's **POINTS COLUMN**.

Points	
✓ 13	25
✓ 14	26
△ 15	27
△ 16	28
5 17	29

### **S6.3 RALLY BEING REPLAYED**

When play is stopped and the rally is replayed due to external interference of the rally:

- S6.3.1 Record nothing on the score sheet.
- S6.3.2 Verify the visible scoreboard reflects the correct score and no points were inadvertently added or removed.

## S7 RECORDING SERVICE FAULTS

### S7.1 RECORDING THE SERVICE ROUND

If a wrong server, time violation, or serving team penalty occurs:

S7.1.1 On the first service of that round, do not record a checkmark (✓) through the **SERVICE ROUNDS** number.

S7.1.2 After the first service of that round, do not remove the checkmark (✓).

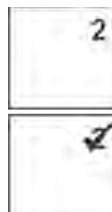

### S7.2 ROTATIONAL FAULT (WRONG SERVER)

When an incorrect player is in the service area preparing to serve:

S7.2.1 Wait until the incorrect player contacts the ball for service.

- a. Immediately notify the 2nd referee after the incorrect player contacts the ball.

S7.2.2 Record the exit score in the **SERVICE ROUNDS** box of the player **who should have served**.

- a. No checkmark (✓) is recorded or removed.

S7.2.3 No **REMARK** or **SANCTION** is recorded.

S7.2.4 Any points earned during the rotational fault must be removed from the score sheet.

- a. Record an appropriate statement in the **REMARKS** section.

REMARKS
ROTATIONAL FAULT, CANCELLED
PTS 10-11, B, SET 2, 11-7

### S7.3 SERVICE FAULT (TIME VIOLATION)

When a server fails to contact the ball within 8 seconds or for any other reason does not contact the ball for service after the 1st referee beckons for service:

S7.3.1 Record the exit score in the **SERVICE ROUNDS** box of that server.

- a. It

S7.3.2 No **REMARK** or **SANCTION** is recorded.

## S8 RECORDING GAME CAPTAIN CHANGES

During play, there must always be a game captain on the court.

### S8.1 TEAM CAPTAIN FROM ROSTER (IF ROSTERS ARE USED)

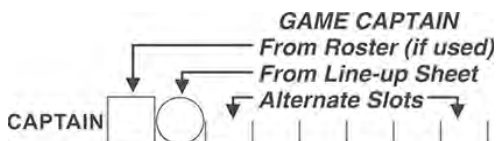

- S8.1.1 When the team captain indicated on the roster (in the **Captain** box) is on the court, he/she is the game captain.



### S8.2 TEAM CAPTAIN FROM LINE-UP SHEET

- S8.2.1 When the team captain indicated on the line-up sheet (in the **Captain** circle) is on the court, he/she is the game captain.

### S8.3 TEAM CAPTAIN LEAVES THE COURT

- S8.3.1 An alternate player on the court must be assigned the role of game captain and is recorded in the alternate slots.

- S8.3.2 When no alternate game captain is recorded:

- Inform the 2nd referee that an alternate game captain needs to be assigned.
- Record the alternate game captain's number in the first available alternate slot.

- S8.3.3 When an alternate game captain is recorded:

- Report the alternate game captain's number to the 2nd referee (10 in the diagram below).

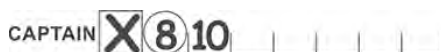

### S8.4 ALTERNATE GAME CAPTAIN LEAVES THE COURT

- S8.4.1 Inform the 2nd referee that a new alternate game captain needs to be assigned.

- S8.4.2 Slash the exiting number in the alternate slots.

S8.4.3 Record the new alternate game captain's number in the next available alternate slot.

**Example:** 10 leaves the court and 9 is the alternate captain

**NOTE:** When 10 re-enters the court, 9 remains the alternate game captain.



## S9 SUBSTITUTIONS

### S9.1 GENERAL INFORMATION

- S9.1.1 Each team is limited to 12 team substitutions per set.
- S9.1.2 Players may enter a set an unlimited number of times within the team substitution limit, but always in the same rotational position relative to teammates.
- S9.1.3 An unlimited number of players are allowed to substitute into a rotational position.

### S9.2 LEGAL SUBSTITUTIONS

**A legal substitution must meet all the following:**

- S9.2.1 The request must be within the team substitution limit.
- S9.2.2 When using rosters:
  - a. The substitute must be on the roster.
  - b. National Scorers: Available substitutes must have been recorded in the Legal Substitutes section.
- S9.2.3 The substitute must enter in the correct rotational position.
- S9.2.4 The substitute cannot have been:
  - a. Replaced by an exceptional substitution during the match;
  - b. Declared unable to play during the match;
  - c. Expelled during the set;
  - d. Disqualified during the match.

### S9.3 ADMINISTERING SUBSTITUTIONS

When the 2nd referee authorizes a substitution.

- S9.3.1 Confirm the legality of the substitution.
  - a. Immediately notify the 2nd referee if the substitution is not legal.
  - b. Remove any incorrectly recorded substitution information (if any).
- S9.3.2 Record the substitution.
- S9.3.3 Notify the 2nd referee when a team has used its 9th, 10th, 11th, and 12th substitutions.
- S9.3.4 Display the READY signal to the 2nd referee.

### S9.4 MULTIPLE SUBSTITUTIONS (SAME TEAM)

The 2nd referee will authorize a pair to exchange followed by another pair until all substitutions have been completed.

- S9.4.1 Administer each substitution separately using the procedures above.
  - a. Confirm legality.
  - b. Record substitution.
  - c. Notify 2nd referee of the 9th, 10th, 11th, and 12th substitutions.
  - d. Display the **READY** signal to confirm all substitutions for that team have been recorded.

### S9.5 SIMULTANEOUS SUBSTITUTION BY BOTH TEAMS

When both teams request substitutions during the same dead ball.

- S9.5.1 Administer each substitution in the same order as authorized by the 2nd referee.
- S9.5.2 Display the READY signal one time for each side.

### S9.6 RECORDING SUBSTITUTIONS

- S9.6.1 Record the substitution in the first available row in the **Score at Substitution** section beneath the player number leaving the set.
  - a. Record the entering player number in the left box.

- b. Record the score at time of substitution in the right box.

IV	
2	
9	3:2
	:

- S9.6.2 Record the total number of team substitutions used by slashing the next un-slashed number in the **Substitutions** row beneath the **SERVICE ROUNDS** section.

3	6	3	6
<b>Substitutions</b> / 2 3			

- S9.6.3 When rosters are used and this is the first time the player has entered the game:
- Slash the player number in the **Legal Substitutes** section.
  - National Scorers: Must slash the player number in the Legal Substitutes section.

### S9.7 RECORDING MORE THAN EIGHT (8) SUBSTITUTIONS IN ONE ROTATIONAL POSITION

- S9.7.1 Record the substitution in the available **SCORE at SUBSTITUTION** boxes in an adjoining column.
- S9.7.2 Draw a dark line around the adjoining **SCORE at SUBSTITUTION** column area to indicate this information belongs with the original substitution position (see diagram below).



I	II	III	IV	V	VI
2	16	5	10	7	4
:	:	3 1:2	:	:	:
:	:	5 2:4	:	:	:
:	:	3 8:7	:	:	:
:	:	5 9:8	:	:	:
:	:	3 12:12	3 21:17	:	:
:	:	5 13:12	5 22:18	:	:
:	:	3 18:14	3 24:24	:	:
:	:	5 19:15	5 25:24	:	:

## S10 EXCEPTIONAL SUBSTITUTIONS

### S10.1 WHEN PERMITTED

S10.1.1 A player (except a Libero) who cannot continue playing due to injury/illness or expulsion/disqualification should be substituted legally or, if in the back row, legally replaced by the Libero.

S10.1.2 If this is not possible, the team is entitled to make an exceptional substitution.

### S10.2 PRIORITY FOR EXCEPTIONAL SUBSTITUTION

S10.2.1 By the starter or a substitute who has played in the position of the injured/ill/expelled/disqualified player, or by any substitute who has not already participated in the set;

S10.2.2 by any substitute on the bench, regardless of position previously played;

S10.2.3 by the Libero.

### S10.3 RECORDING EXCEPTIONAL SUBSTITUTIONS

S10.3.1 Circle the injured player's number in the **SERVICE ORDER** or **SCORE at SUBSTITUTION** section to indicate that the player is prohibited from returning to the match.

III	IV
2	⑥
:	14 :

- S10.3.2 Record the incoming player's number in the next available substitution box.
- S10.3.3 Do not record the score in the **SCORE at SUBSTITUTION** section.
- S10.3.4 Do not slash any substitution number in the Substitutions row beneath the **SERVICE ROUNDS** section. An exceptional substitution is not counted as one of the team's allowable team subs.

S10.3.5 **RECORD REMARKS**

- a. Record a comment in the **REMARKS** section, noting the action (EX SUB), the uniform numbers of the incoming player and injured player, the team name or letter designation, the set number, and the score at the time of the exceptional substitution.

<b>REMARKS</b>
EX SUB, #12 FOR #16, A, SET 1, 9-12

- b. If more sets will be played in the match:
- c. Record this remark onto all subsequent score sheets.
- d. This player will be recorded in the **Legal Substitutes** section of subsequent score sheets inside a circle. This indicates that this player cannot be used as a legal substitute.

## **S10.4 EXCEPTIONAL SUBSTITUTIONS INVOLVING THE LIBERO**

As the last option, a Libero may be used as the exceptional substitute.

- S10.4.1 If the team has two Liberos, either Libero may be selected as the exceptional substitute and the team will be limited to one Libero for the remainder of the match.
- S10.4.2 If the team is using one Libero, the team will play the remainder of the match with no Libero.
- S10.4.3 Record the selected Libero's number in the next available substitution box.
- S10.4.4 Do not record the score in the **SCORE at SUBSTITUTION** section.
- S10.4.5 **RECORD THE EXCEPTIONAL SUBSTITUTE**
- a. Slash the selected Libero's number in the Libero# box next to the

team name.

09:00	Team	EAGLES				Liberos	X 1 3	A B A
I	II	III	IV	V	VI			
2	(16)	5	12	7	4			
:	11	:	:	:	:	:	:	

- The Libero's number is also slashed on the Libero Control Sheet.
- When two (2) Liberos are designated for the match and more sets will be played:
- Record this slash onto all subsequent set score sheets and the Libero Control Sheet.

Set 2	A B	Liberos	X 3	Team	EAGLES	End	:
-------	-----	---------	-----	------	--------	-----	---

#### S10.4.6 RECORD REMARKS

- Record a comment in the REMARKS section as follows:

REMARKS
EX SUB LIBERO #11 FOR #16, A.
SET 1,9-12

- If more sets will be played in the match, record this remark on all subsequent score sheets.

## S11 TIME-OUTS

### S11.1 RECORDING TIME-OUTS

- Record the score at the time-out in the **TIME-OUTS** box located under the team's **POINTS COLUMN** section.
- Record the first time-out in the top box.
- Record the second time-out in the lower box.

Time Outs	Time Outs
7:10	12:13
22:20	:

### S11.2 COMMUNICATING WITH second referee

- Immediately after recording the time-out:
  - Visually signal the number of time-outs taken by each team to the 2nd referee.

S11.2.2 At the conclusion of the time-out:

- a. Display the ready signal to the 2nd referee.

## S12 IMPROPER REQUEST

The IMPROPER REQUEST section is used to denote that a team has made an improper request.

### S12.1 RECORDING AN improper request

S12.1.1 Record an X over the appropriate A or B for the team that made the improper request.



S12.1.2 If more sets will be played in this match;

- a. Record this Improper Request onto all subsequent score sheets.

S12.1.3 A team may be charged with an improper request after being sanctioned with a delay.

## S13 SANCTIONS BOX

### S13.1 GENERAL INFORMATION

S13.1.1 The **SANCTIONS** section is used to record sanctions applied by the 1st referee.

S13.1.2 Information recorded in the **SANCTIONS** section needs no further notation in the **REMARKS** section.

S13.1.3 Each recorded sanction should include:

- a. the specific sanction:
  - 1) delay or misconduct warning,
  - 2) delay or misconduct penalty,
  - 3) expulsion or disqualification;
- b. the player number or bench personnel code (if applicable);
- c. the team at fault (use **A** or **B** team designation);
- d. the set number;
- e. the score at the time of the sanction.

S13.1.4 If more sets will be played in the match:

Record **all sanctions** onto all subsequent score sheets.

S13.1.5 When a penalty is recorded in the **Penalty** column, there must be a corresponding penalty point recorded in the opponent's **Points** column.

### S13.2 DELAY WARNING (Yellow card shown on wrist)

S13.2.1 Record a **D** in the **W Warn** column, record the team at fault, the set number, and the score.

a. There is only one yellow card delay warning per team/per match.

	W Warn	P Penalty	E Expel	D DisQ	(A) (B)	SET	SCORE
S							
A	D				B	3	8:5

### S13.3 MISCONDUCT WARNING (Yellow card)

S13.3.1 Record the player number or bench personnel code (refer to the legend next to the **SANCTIONS** box) in the **W Warn** column, record the team at fault, the set number, and the score.

a. There is only one yellow card misconduct warning per team/ per match.

	W Warn	P Penalty	E Expel	D DisQ	(A) (B)	SET	SCORE
S							
A	C				A	1	7:6

### S13.4 DELAY PENALTY (Red card shown on wrist)

S13.4.1 Record a **D** in the **P Penalty** column, the team at fault, the set number, and the score at the time of the penalty.

S13.4.2 If penalty is against the serving team, record the serving team's exit score.

	W Warn	P Penalty	E Expel	D DisQ	(A) (B)	SET	SCORE
S							
A		D			A	2	3:4

S13.4.3 Record the awarded penalty point. Slash and circle the opposing team's next point in the **POINTS COLUMN**.

Team A			Team B		
Points			Points		
♯	13	25	♯	13	25
♯	14	26	♯	14	26
♯	15	27	♯	15	27
♯	16	28	♯	16	28
♯	17	29	⓪	17	29

For an exceptional substitution for the expelled player, use the procedure outlined in S10.3.

### S13.5 MISCONDUCT PENALTY (Red card)

S13.5.1 Record the player number or bench personnel code (refer to the legend next to the SANCTIONS box), in the **P Penalty** column, the team at fault, the set number, and the score at the time of the penalty.

S13.5.2 If penalty is against the serving team, record the serving team's exit score.

	W Warn	P Penalty	E Expel	D Disq	(A) (B)	SET	SCORE
S							
A		5			B	3	6:2

S13.5.3 Record the awarded penalty point. Slash and circle the opposing team's next point in the **POINTS COLUMN**.

### S13.6 MISCONDUCT EXPULSION (Red and Yellow card shown together)

S13.6.1 A team member sanctioned by expulsion;

- Shall not play for the rest of the set;
- Must be substituted legally or exceptionally if on the court. If no legal or exceptional substitute is available, the team is declared incomplete.
- Must remain seated on the bench (player or substitute), or must leave the player area, bench, and warm-up area (any other team member), for the remainder of the set.

#### S13.6.2 RECORD THE EXPULSION

- Record the player number or bench personnel code (refer to the legend next to the **SANCTIONS** box), in the **E Expel** column, the team at fault, the set number, and the score at the time of the expulsion.

	W Warn	P Penalty	E Expel	D DisQ	(A) (B)	SET	SCORE
S			8		B	2	8:5
A							

- b. No loss of service or penalty point awarded.

### S13.6.3 RECORD THE REQUIRED SUBSTITUTION

- Circle the expelled player's number in the **SERVICE ORDER** or **SCORE AT SUBSTITUTION** section indicating the player shall not play for the rest of this set.
- Complete recording the substitution using the procedure as outlined in **S9.6**.

I	II	III	IV	V	VI
2	(8)	5	12	7	4
:	6 8:5	:	:	:	:
Substitutions # 2 3 4 5 6 7 8 9 10 11 12					

- For an exceptional substitution for the expelled player, use the procedure outlined in S10.3.

### S13.7 MISCONDUCT DISQUALIFICATION (Red and Yellow card shown apart)

S13.7.1 A team member sanctioned by disqualification:

- Must be substituted legally or exceptionally if on the court. Otherwise, the team is incomplete.
- Must leave the Competition-Control Area for the rest of the match. (Must leave the gym)

### S13.7.2 RECORD THE DISQUALIFICATION

- Record the player number or bench personnel code (refer to the legend next to the **SANCTIONS** box), in the **D DisQ** column, the team at fault, the set number, and the score at the time of the disqualification.

### S13.7.3 RECORD THE DISQUALIFICATION

- Record the player number or bench personnel code (refer to the legend next to the **SANCTIONS** box), in the **D DisQ** column, the team at fault, the set number, and the score at the time of the disqualification.

	W Warn	P Penalty	E ExpeI	D DisQ	(A) (B)	SET	SCORE
S				9	B	2	8:7
A							

- b. No loss of service or penalty point awarded.

### S13.7.4 RECORD THE REQUIRED SUBSTITUTION

- a. Circle the disqualified player's number in the **SERVICE ORDER** or **SCORE AT SUBSTITUTION** section indicating the player shall not play for the rest of the match.
- b. Complete recording the substitution using the procedure as outlined in **S9.6**.

I	II	III	IV	V	VI
2	8	5	12	7	4
:	:	:	3:4	:	:
:	:	:	6:7	:	:
Substitutions 2 3 4 5 6 7 8 9 10 11 12					

- c. This player will be recorded in the **Legal Substitutes** section of subsequent score sheets inside a circle. This indicates that this player cannot be used as a legal substitute.
- d. For an exceptional substitution for the disqualified player, use the procedure outlined in S10.3

## S14 REMARKS SECTION

### S14.1 USE OF THE REMARKS SECTION.

S14.1.1 Do Not record frivolous remarks.

S14.1.2 Record any noteworthy situation that occurs and is pertinent to the progress of the set.

S14.1.3 Record information that cannot be recorded in the **SANCTIONS** box:

- a. Reason for Referee actions such as:
- 1) Defaulted/Forfeited set;
  - 2) Points canceled by referees;
  - 3) Unusually long delays not covered by delay sanctions.
- b. Late Match Start
- c. Teams in DEFAULT;
- d. FORFEITS;



- e. Incomplete teams;
- f. Exceptional Substitutions (EX SUB);
- g. Penalties that cannot be recorded in the **SANCTIONS** box, including late work teams, violation of event rules;
- h. Other.

S14.1.4 Record additional information as needed:

- 1) Player number or bench personnel code; Team (A or B);
- 2) Set number;
- 3) Score at time of situation.

### S14.2 PREFERRED RECORDING TECHNIQUES

S14.2.1 (Preferred Technique) Record information in the **REMARKS** section in the same order as the **SANCTIONS** box.

S14.2.2 The order of recording information in the **REMARKS** section is not critical as long as all necessary information is recorded.

### S14.3 EXAMPLE OF LATE START AND LATE WORK TEAM PENALTY

S14.3.1 Record the awarded penalty points. Slash and circle first three points in Team A's **POINTS COLUMN**.

REMARKS											
LATE START DUE TO PREVIOUS MATCH LATE WORK TEAM PREVIOUS MATCH, B. 3 PT PENALTY	Team A										
	<table border="1" style="border-collapse: collapse; width: 100%;"> <thead> <tr> <th colspan="2" style="text-align: center;">Points</th> </tr> </thead> <tbody> <tr> <td style="text-align: center;">③ 13 25</td> <td style="width: 20px;"></td> </tr> <tr> <td style="text-align: center;">③ 14 26</td> <td></td> </tr> <tr> <td style="text-align: center;">③ 15 27</td> <td></td> </tr> <tr> <td style="text-align: center;">4 16 28</td> <td></td> </tr> </tbody> </table>	Points		③ 13 25		③ 14 26		③ 15 27		4 16 28	
Points											
③ 13 25											
③ 14 26											
③ 15 27											
4 16 28											

## S15 SCORING ACTIONS INVOLVING THE LIBERO

### S15.1 LIBERO UNABLE TO PLAY DUE TO ILLNESS, INJURY, OR DECLARATION

S15.1.1 **REMARKS**

- a. Record a comment in the **REMARKS** section when any Libero becomes unable to play.

REMARKS
LIBERO #11 UNABLE TO PLAY, A. SET 1,8-6

If more sets will be played in the match, record this remark onto all subsequent score sheets.

### S15.1.2 RECORD THE LIBERO (UNABLE TO PLAY)

- Circle the number of the Libero unable to play (next to the team name). This player will be unable to play for the remainder of the match.

Start	09:00	Team	EAGLES	Libero	(11)	X	A	B	X
-------	-------	------	--------	--------	------	---	---	---	---

- The Libero number is also circled on the Libero Control Sheet.
- When two (2) Liberors are designated for the match and more sets will be played:
  - Record this circle onto all subsequent set score sheets and the Libero Control Sheet.

Set 2

Libero	(11)	3	Team	EAGLES	End	:
--------	------	---	------	--------	-----	---

### S15.2 AN EXPELLED LIBERO

S15.2.1 A Libero sanctioned by expulsion;

- Shall not play for the rest of the set;
- Must be replaced immediately, if on the court.
- Must remain seated on the bench.

#### S15.2.2 RECORD THE EXPULSION

- Record the Libero number in the **E Expel** column, the team at fault, the set number, and the score at the time of the expulsion.

	W Warn	P Penalty	E Expel	D DisQ	(A) (B)	SET	SCORE
S							
A			11		A	1	8:6

No loss of service or penalty point awarded.

#### S15.2.3 Record The Expelled Libero

- Circle the number of the expelled Libero (next to the team name).

Start	09:00	Team	EAGLES	Libero	(11)	X	A	B	X
-------	-------	------	--------	--------	------	---	---	---	---

The Libero number is also circled on the Libero Control Sheet.

### S15.3 A DISQUALIFIED LIBERO

S15.3.1 A Libero sanctioned by disqualification;

- Must be replaced immediately, if on the court.  
Must leave the Competition-Control Area for the rest of the match.

(Must leave the gym)

### S15.3.2 RECORD THE DISQUALIFICATION

- Record the Libero number in the **D DisQ** column, the team at fault, the set number, and the score at the time of the disqualification.

S	W	P	E	D	(A)	SET	SCORE
	Warn	Penalty	Expel	DisQ	(B)		
A				3	A	1	4:9

No loss of service or penalty point awarded.

### S15.3.3 RECORDING THE DISQUALIFIED LIBERO

- Circle the number of the disqualified Libero (next to the team name).

Start	09:00	Team	EAGLES	Libero#	(3)	X	A	A	S
-------	-------	------	--------	---------	-----	---	---	---	---

- The Libero number is also circled on the Libero Control Sheet.
- When two (2) Liberos are designated for the match and more sets will be played:
  - Record this circle onto all subsequent set score sheets and the Libero Control Sheet.

Set 2									
X	A	A	Libero#	(11)	3	Team	EAGLES	End	+

## S15.4 LIBERO RE-DESIGNATION

S15.4.1 Libero re-designation is permitted only when a team has only one Libero and that Libero becomes unable to play.

S15.4.2 If the team re-designates a Libero, record the re-designation in the REMARKS section.

REMARKS
REDESIGNATED LIBERO #8, A, SET 1, 10-8

### S15.4.3 RECORD THE RE-DESIGNATED LIBERO

- Record the number of the re-designated Libero above the Libero box (next to the team name).

Start 09:00		Team EAGLES		8	
(11)		X		A A X	
I	II	III	IV	V	VI
2	8	5	12	7	4
12 8 7		:	:	:	:

- This number is also recorded on the Libero Control Sheet for the current set.
- When two (2) Liberos are designated for the match and more sets will be played:
  - Record this number onto all subsequent set score sheets and the Libero Control Sheet.

Set 1		8	
Start 09:00		Team EAGLES	
(11)		(3) A A X	
Set 2		8	
X A A (11) (3)		Team EAGLES	
R S		End . .	

Points	Points
<del>13</del> 25	<del>13</del> 25
<del>14</del> 26	<del>14</del> 26
<del>15</del> 27	<del>15</del> 27
<del>16</del> 28	<del>16</del> 28
<del>17</del> 29	<del>17</del> 29
<del>18</del> 30	<del>18</del> 30
<del>19</del> 31	<del>19</del> 31
<del>20</del> 32	<del>20</del> 32
21 33	21 33
22 34	22 34
23 35	23 35
24 36	24 36

## S16 SET POINT SIGNAL

### S16.1 NOTIFY THE 2<sup>nd</sup> REFEREE WHEN EITHER TEAM'S NEXT POINT WOULD END THE SET.

- S16.1.1 Place the index finger on the front of the shoulder on the side of the team with the set point.
- Repeat the signal only if a different set point situation occurs.

## S17 POST SET PROCEDURES

### S17.1 FINAL POINT SCORED

- S17.1.1 Slash the final point in the **POINTS** column.
- S17.1.2 Cross forearms in front of the chest (palms facing toward body) to indicate the end of the set/match.
- S17.1.3 Record the point total as the final exit score.
- When final point is scored by the serving team:
    - Record the final exit score in the current **SERVICE ROUNDS** box.

- b. When final point is scored by the receiving team on the opponent's loss of rally:
- 1) Record the final exit score in the next available **SERVICE ROUNDS** box.
  - 2) Do not record a checkmark (✓) through the **SERVICE ROUNDS** box number.



**S17.2 FROM THIS POINT FORWARD RECORD ALL INFORMATION USING BLUE/BLACK INK**

**S17.3 END TIME AND FINAL EXIT SCORES**

Use blue/black ink.



S17.3.1 Record the set ending time in the **END TIME** box.

- a. End time is when the first referee signals the end of set.

S17.3.2 Circle the final exit score in the **SERVICE ROUNDS** box for each team

<del>X</del>	3 <sup>✓</sup>	5 <sup>✓</sup>	10 <sup>✓</sup>	18 <sup>✓</sup>	22 <sup>✓</sup>
24 <sup>✓</sup>	25 <sup>2</sup>				

**S17.4 POINTS COLUMN**

Use blue/black ink.

S17.4.1 Do not circle the final point in the **POINTS** column, unless it was the result of a penalty point.

S17.4.2 Cancel all unused points using the **T-Bar** Method.

S17.4.3 **T-Bar** Method

- a. At the end of each set, using a straight edge:
  - 1) Draw a horizontal line across the column underneath the last point recorded.

- 2) Draw a vertical line through the numbers from the horizontal line to the bottom of the column.
- 3) For each unused column containing a number, draw a vertical line through the numbers from top to bottom of the column.

### S17.5 SET RESULTS

Use blue/black ink.

- S17.5.1 Record the winning team name and score in the upper section (**Winning**) of the appropriate **SET RESULTS** box.
- S17.5.2 Record the losing team name and score in the lower section (**Losing**) of the appropriate **SET RESULTS** box.

TEAM	SET RESULTS	Score
Winning	<b>EAGLES</b>	<b>25</b>
Losing	<b>COBRAS</b>	<b>10</b>

### S17.6 SCORE SHEET REVIEW

- S17.6.1 Review for completeness and accuracy
- a. Start and End Times
  - b. Confirm substitutions areas all agree
    - 1) Count substitutions in SCORE at SUBSTITUTION section.
    - 2) Compare to total substitutions in **Substitutions** row.
- S17.6.2 Check accuracy of scores by matching:
- a. Final Exit Score;
  - b. Last Point recorded in **POINTS** column;
  - c. Scores recorded in **SET RESULTS**.
- S17.6.3 Check accuracy of **SET RESULTS**
- a. Winning and Losing Teams are correct;
  - b. Scores are accurately recorded and match other scores.

### S17.7 SIGNATURE

Use **blue/black ink**.

When using the 1-set score sheet.

- S17.7.1 Sign the score sheet after the review.

- S17.7.2 When using the 2-set score sheet, sign the score sheet after the 2nd set has been completed and reviewed.

SIGNATURES	
Scorer	<i>Scorer's Signature</i>
1st Referee	

## S17.8 PREPARING ADDITIONAL SCORE SHEETS

- S17.8.1 Record all sanctions and pertinent remarks that affect the administration of remaining sets onto all subsequent score sheets.
- S17.8.2 Verify all players either disqualified or replaced through exceptional substitution are not listed as Legal Substitutes.

## S18 POST MATCH PROCEDURE

### S18.1 RECORD MATCH RESULTS

Use blue/black ink.

- S18.1.1 Record the winning team name in the **MATCH WINNER** box on all score sheets used in the match.
- S18.1.2 Record the number of sets won and lost.

TEAM	MATCH WINNER	Sets	W	L
<b>EAGLES</b>			<b>2</b>	<b>1</b>

- S18.1.3 If a tie occurs (some competitions play two sets only) record **SPLIT/TIED** as the winning team.

TEAM	MATCH WINNER	Sets	W	L
<b>SPLIT/TIED</b>			<b>1</b>	<b>1</b>

### S18.2 1ST REFEREE SIGNATURE

Use blue/black ink.

- S18.2.1 Assist the 1st referee (as needed) as he/she reviews and signs all used score sheets.

SIGNATURES	
Scorer	<i>Scorer's Signature</i>
1st Referee	<i>First Referee Signature</i>

### **S18.3 SCORE SHEETS**

S18.3.1 Process completed score sheets as instructed by tournament management.

### **S18.4 SCORER TABLE**

S18.4.1 Before leaving:

- a. Discard all work papers, Line-up Sheets, Libero Control Sheet.
- b. Remove all personal items;
- c. Discard all trash.





## S19 DECIDING SET SCORE SHEET

### S19.1 DECIDING SET SCORE SHEET

NOTE: When teams will not change courts during a deciding set, a non-deciding set score sheet may be used, or use only the two right-side panels on a deciding set score sheet.

A deciding set score sheet is used for multiple match situations:

S19.1.1 When a best-of-three match is tied 1-1 or a best-of-five match is tied 2-2, a deciding set is played.

- a. The set is played to fifteen (15) points with a minimum lead of two (2) points.

Teams will change courts at eight (8) points.

S19.1.2 When a playoff set to twenty-five (25) points is played.

- a. The set is played to twenty-five (25) points with a minimum lead of two (2) points.

Teams will change courts at thirteen (13) points.

S19.1.3 When a playoff set to fifteen (15) points is played.

- a. The set is played to fifteen (15) points with a minimum lead of two (2) points.

Teams will change courts at eight (8) points.

S19.1.4 When the third set of an 'automatic 3-set' match is played like a deciding set.

- a. A coin toss is conducted.

The set is played to twenty-five (25) points with a minimum lead of two (2) points.

- b. Teams will change courts at thirteen (13) points.

### S19.2 CHARACTERISTICS OF A DECIDING SET SCORE SHEET

S19.2.1 A deciding set score sheet contains:

- a. All the information of a non-deciding set score sheet.

- 1) Due to the change of courts, scoring information is recorded differently than in a non-deciding set.

- b. A **LEFT** section which is:

- 1) Used to record scoring information about the team starting on the left court.

- 2) Not used after the court change.

- c. A **MIDDLE** section which is
  - 1) Used to record scoring information about the team starting on the right court and finishing on the Left court;
  - 2) Used during the entire set.
- d. A **RIGHT** section which is:
  - 1) Used before the court change, to record certain information about the team starting on the **left** court.
  - 2) Used after the court change, to record all scoring information about the team now on the **right** court.

### S19.3 PREPARING A DECIDING SET SCORE SHEET

#### Use blue/black ink.

- S19.3.1 Record 3, 5 or 1 (for a single playoff set) in the **Set** box.
- S19.3.2 Record all heading information and all officials' names.
- S19.3.3 Record all sanction information from the previous score sheets (if any).
- S19.3.4 Record any pertinent information in the **REMARKS** section from the previous score sheets (if any).

### S19.4 AFTER THE COIN TOSS

#### Use blue/black ink.

- S19.4.1 For the team starting on the left court:
  - a. Record all information on both the **LEFT** and **RIGHT** sections.
- S19.4.2 For the team starting on the **right** court:
  - a. Record all information on the **MIDDLE** section.
- S19.4.3 Record the following information:
  - a. Team **A/B** designation from **Set 1** in the **A/B** circle.
    - 1) For a one (1) set playoff the team starting on the **left** court will be designated Team **A**.  
Team Name in the **TEAM INFO** section.
- S19.4.4 Record Serve and Serve Receive.
  - a. For the team serving first:
    - 1) Record an **X** through the (S).
  - b. For the team receiving first:

- 1) Record an **X** through the **(R)**.
- 2) Record an **X** in box 1 of the **SERVICE ROUNDS** section for the player in **SERVICE ORDER I**.

If the team receiving first is on the **left** court, Record the **X** in the **LEFT** section **ONLY**.

## S19.5 RECORDING INFORMATION AFTER LINE-UP SUBMISSION

**Use blue/black ink.**

S19.5.1 For the team starting on the left court:

- a. On the **LEFT** section, record:
  - 1) The starting line-up;
  - 2) The **CAPTAIN** information;
  - 3) The **Libero#** information.
- b. On the **RIGHT** section, record:
  - 1) The starting line-up;
  - 2) The **CAPTAIN** information.

S19.5.2 For the team starting on the **right** court:

- a. On the **MIDDLE** section, record:
  - 1) The starting line-up;
  - 2) The **CAPTAIN** information;
  - 3) The **Libero#** information.

EXAMPLE

No Rosters are available.

COBRAS receiving from **left** court. EAGLES serving from **right** court.

SET 3 LIBERO LINE-UP SHEET TEAM COBRAS 11 X						SET 3 LIBERO LINE-UP SHEET TEAM EAGLES 16 20																	
IV		III		II		IV		III		II													
47		10c		8		14		1		3													
V		VI		I		V		VI		I													
23		2		15		5c		7		9													
COACH SIGNATURE <i>Cobra Leader</i>						COACH SIGNATURE <i>Eagle Boy</i>																	
CAPTAIN X 10						CAPTAIN X 5						CAPTAIN X 10						Set 3					
COBRAS						EAGLES						COBRAS											
I	II	III	IV	V	VI	I	II	III	IV	V	VI	I	II	III	IV	V	VI						
15	8	10	47	23	2	9	3	1	14	5	7	15	8	10	47	23	2						
Substitutions: 1 2 3 4 5 6 7 8 9 10 11 12						Substitutions: 1 2 3 4 5 6 7 8 9 10 11 12						Substitutions: 1 2 3 4 5 6 7 8 9 10 11 12											

## S19.6 LEGAL SUBSTITUTES SECTION

Use blue/black ink.

S19.6.1 Complete the Legal Substitutes section (S3.12) for team starting on left court on:

- The LEFT section;
- the RIGHT section.;

S19.6.2 Complete the Legal Substitutes (S3.12) section for team starting on right court on:

- The MIDDLE section.

## S19.7 RECORD THE START TIME

Use blue/black ink.

## S20 DECIDING SET PROCEDURES

### S20.1 RECORD INFORMATION USING EITHER PENCIL OR BLUE/BLACK INK

### S20.2 BEFORE THE COURT CHANGE (IF USED)

S20.2.1 The set proceeds like any other set until the court change. S20.2.2 For the team on the **left** court:

- Record all actions on the **LEFT** section;  
Record the following on both the **LEFT** and **RIGHT** sections:
  - All substitution information;
  - All **CAPTAIN** changes;

3) All **TIME OUTS**.

b. **DO NOT RECORD** the following information on the **LEFT** section:

- 1) Points in the **POINTS Column**;
- 2) Exit Scores in the **SERVICE ROUNDS**.

S20.2.3 For the team on the right court:

a. Record all actions on the **MIDDLE** section;

S20.2.4 Notify the 2nd referee when either team's next point would cause the **COURT CHANGE**.

CAPTAIN X10 8 COBRAS													CAPTAIN X5 EAGLES													CAPTAIN X10 8 COBRAS												
09:00													16:20																									
I	II	III	IV	V	VI	Points	I	II	III	IV	V	VI	Points	I	II	III	IV	V	Points at Chg	I	II	III	IV	V	Points													
15	8	10	47	23	2		9	3	1	14	5	7		15	8	10	47	23		15	8	10	47	23														
			7	2	3												7	2	3																			







S23.1.4 Points will be removed at the direction of the referees.

The scorer may assist the referees but must follow all directions of the referees.

S23.1.5 Remove points in the **POINTS COLUMN** as **INCORRECT INFORMATION** (S1.2).

S23.1.6 Record a remark in the **REMARKS** section.

REMARKS
ILLEGAL PLAYER ON CT, PTS 11-14 REMOVED, B, SET 2, 14-8

S23.1.7 All penalty points removed must be restored.

- A remark specifying the number of penalty points restored must be made in the **REMARKS** section. (See Scoring Example)

S23.1.8 When the team at fault is serving:

- Remove points in the **POINTS COLUMN**
- Opponents are awarded a point and service;
  - Record this slashed rally point.
- Record the exit score that reflects the score after all points have been removed.

S23.1.9 When the team at fault is receiving:

- No points will be removed.

#### **EXAMPLE**

##### **TEAM B AT FAULT (SERVING)**

- A wrong player entered when Team B had 15 points; Team B currently has 18 points.
- #4 is serving

##### **Team B - Exit Scores before fault discovered**

- Team B's score goes back to 15 (removal of points 16-18)
- Team A awarded point and service

##### **TEAM B AT FAULT (RECEIVING)**

A wrong player entered when Team B had 10 points

Fault is discovered during Team A's term of service

No points are removed, and Team A continues to serve.

## S24 PROTESTS

### S24.1 When a protest is accepted by the 1st referee:

S24.1.1 When a Protest Committee makes an immediate ruling before play is resumed:

In the **REMARKS** section:

- a. Record that a protest has been accepted.  
**Do not record** the protest facts.
- b. Record the decision (UPHELD/DENIED).
- c. Record any time delay caused by the protest as directed by the referees.

As a courtesy, scorer may track the time delay.

REMARKS
PROTEST, B, SET 2, 11-9, DENIED, 15 MIN DELAY

NOTE: As directed by the tournament staff, Protest Committee, or Head Referee, a penalty (red card) may need to be recorded in the SANCTIONS box and noted in the REMARKS as a penalty for protesting a judgment decision.

S24.1.2 When a ruling is not immediate:

In the **REMARKS** section:

- a. Record that a protest has been accepted.
- b. Record the Protest facts as specified in USAV 5.1.2.

REMARKS
PROTEST, B, SET 2, 11-9, PROTEST FACTS PER USAV 5.1.2.1

## S25 FORFEITS

### S25.1 A FORFEIT OF SETS OR MATCHES CAN OCCUR FOR REASONS SUCH AS:

S25.1.1 Team declared in default for:

- a. Refusal to play;
- b. Not appearing on playing court on time.

S25.1.2 Team declared INCOMPLETE for the set or match.

S25.1.3 Team does not have six players to begin a match.

**S25.2 A TEAM DECLARED IN DEFAULT FORFEITS THE MATCH WITH:**

S25.2.1 The match result of:

- a. 0-3 for a best-of five match;  
0-2 for a best-of-three match-set.
- b. The score for each set will be 0-25.
  - 1) Any sets completed will revert to a score of 0-25.

**S25.3 A TEAM DECLARED INCOMPLETE FOR THE SET OR MATCH FORFEITS THE SET OR MATCH WITH:**

S25.3.1 The incomplete team keeping all points scored and sets won;

S25.3.2 The opponent given the points needed to win the set or the points and sets needed to win the set and match.

**S25.4 A TEAM THAT DOES NOT HAVE SIX PLAYERS TO BEGIN THE MATCH:**

S25.4.1 Forfeits the first set at match time;

S25.4.2 Is given an interval of up to 10 minutes to produce sufficient players to play the next set.

S25.4.3 After the 10-minute interval, if there are still not six (6) players ready to play:

- a. The second set is forfeited.

S25.4.4 If the match is a best-of-three:

- a. The match is forfeited.

S25.4.5 If the match is a best-of-five or automatic three (3) set match:

- a. Another interval of up to 10 minutes is given;  
After the 10-minute interval, if there are still not six (6) players ready to play:
  - 1) The third set is forfeited;
  - 2) The match is forfeited.

## S25.5 RECORDING A FORFEIT FOR AN UNPLAYED SET

Use **blue/black ink**.

S25.5.1 If a set number is not pre-printed in the Set box:

- a. Record the set number of each forfeited set:

S25.5.2 If available complete:

- a. Serving and receiving teams (S3.3);
- b. Team Designation (S3.1);
- c. Team Information (S3.2);
- d. Libero Designation (S3.7);
- e. Game Captains (S3.9);
- f. Starting Line-ups (S3.10).

Points		
<del>1</del>	<del>18</del>	<del>25</del>
<del>10</del>	<del>22</del>	34
<del>11</del>	<del>26</del>	35
<del>12</del>	<del>24</del>	36

S25.5.3 Record the **Start** and **End** Time of the forfeited set.

S25.5.4 Write ‘- - - - **FORFEIT** - - - -’ across the entire score sheet.

CAPTAIN		Set												
I	II	III	IV	V	VI	Points	Points	I	II	III	IV	V	VI	09:00
- - - - <b>FORFEIT</b> - - - -														
1	2	3	4	5	6	7	8	9	10	11	12	13	14	15
16	17	18	19	20	21	22	23	24	25	26	27	28	29	30
31	32	33	34	35	36	37	38	39	40	41	42	43	44	45

S25.5.5 In the POINTS COLUMN:

- a. Do not:
  - 1) Slash and circle any points;
  - 2) Cancel any unused points.

## S25.6 MATCH DECLARED A FORFEIT BEFORE THE FIRST SERVE OF THE MATCH

Use **blue/black ink**.

S25.6.1 Record all heading information (S2.2).

S25.6.2 Record the officials' names (S.2.3).

S25.6.3 Record the first set as a forfeit (S25.5).

S25.6.4 In the **REMARKS** section:

- a. Record comments regarding the circumstances of the forfeit.

REMARKS
FORFEIT MATCH, EAGLES, INSUFFICIENT PLAYERS

S25.6.5 Record the **SET RESULTS**:

- a. WINNING TEAM;  
Set score of 0-25;
- b. For a 2-up sheet:
  - 3) Record both **SET 1** and **SET 2 RESULTS**.

S25.6.6 Follow all POST MATCH PROCEDURES (S18).

## S25.7 FORFEIT DUE TO INSUFFICIENT PLAYERS TO START THE MATCH

**Use blue/black ink.**

S25.7.1 Record all heading information (S2.2).

S25.7.2 Record the officials' names (S.2.3).

S25.7.3 Record the first set as a forfeit (S25.5).

S25.7.4 Record a remark in the **REMARKS** section.

S25.7.5 Record the **SET RESULTS** (S17.5).

S25.7.6 After expiration of the 10-minute interval:

- a. Record remarks in the **REMARKS** section:
  - 1) Indicating the next set is forfeited;  
Record the **SET RESULTS** (S17.5).

S25.7.7 For a best-of-five or automatic three (3) set match repeat S25.7.6 one more time.

S25.7.8 When the match is forfeited:

- a. Record a remark in the **REMARKS** section.  
Follow all **POST MATCH PROCEDURES** (S18).

REMARKS
FORFEIT SET 1, EAGLES, 09:00, INSUFFICIENT PLAYERS FORFEIT SET 2 AND MATCH, EAGLES, 09:10, INSUFFICIENT PLAYERS

## S25.8 FORFEIT AFTER SET BEGINS DUE TO INCOMPLETE TEAM

S25.8.1 Opponent is awarded sufficient points to produce a winning score.

- a. Record these points in the **POINTS COLUMN** as **PENALTY POINTS (S1.6)**.

- 1) Slash and circle each point.

S25.8.2 Record a remark in the **REMARKS** section.

REMARKS
FORFEIT, INCOMPLETE TEAM, B. SET 1, 18-22

S25.8.3 Follow all **POST SET PROCEDURES (S17)**.

S25.8.4 Record the remaining forfeited sets (**S25.5**).

S25.8.5 If the match is forfeited:

- a. Follow all **POST MATCH PROCEDURES (S18)**.

## S25.9 FORFEIT AFTER MATCH BEGINS DUE TO TEAM BEING DECLARED IN DEFAULT

A team could be declared in default for refusing to play when directed by the referees. While this is rare, the scorer needs to be prepared to record this forfeit.

S25.9.1 A team in default forfeits all sets, even those already played or in progress.

- a. The set score will be 0-25 for all sets.

The match score will be:

- 1) 0-2 for a best-of-three match;

- 2) 0-3 for a best-of-five match.

S25.9.2 For all sets played or the set in-progress:

Use **blue/black ink**.

- a. Write '----- **FORFEIT**-----' across the entire score sheet.  
Correct the SET RESULTS box to reflect the opponent winning the set with a score of 0-25.

S25.9.3 Record any remaining forfeited sets (S25.5).

S25.9.4 Record a remark in the REMARKS section.

S25.9.5 Follow all POST MATCH PROCEDURES (S18).

REMARKS
MATCH FORFEIT, TEAM IN DEFAULT, REFUSAL TO PLAY, B, SET 1, 18-22 ...

# NATIONAL EVENT SCORING PROCEDURES

## N1 PROCEDURES

### N1.1 INFORMATION

N1.1.1 Record all information **using blue/black ink**.

### N1.2 ROSTERS

N1.2.1 Obtain a clean, unmarked (excluding verification initials) roster from each team.

N1.2.2 No marks should be written on the roster.

a. A separate notepad/paper is used to assist the roster verification process.

1) Copy roster numbers onto the notepad and make any marks there.

N1.2.3 Roster verification

a. With the assistance of the referees:

1) Verify player uniform numbers are correct and accurate.

2) Verify gender and number of bench personnel.

N1.2.4 Photo ID Verification

a. At the request of Championship staff, check each team member's photo ID against the roster.

N1.2.5 Initial the roster, as verified, in the lower right- hand corner.

### N1.3 LINE-UP SHEETS

N1.3.1 Process using procedures **S3.6-S3.12**.

### N1.4 LEGAL SUBSTITUTES SECTION

N1.4.1 [Required] Record using **S3.12**;

a. Use line-up sheet and notepad from N1.2.2.a to assist recording.

N1.4.2 The Liberos are not **Legal Substitutes**. N1.4.3 Manage **Legal Substitutes** using **S9.6.3**.



Diagram 3



# LIBERO CONTROL SHEET

(A) SP 

Libero	
L	R

**TEAM NAME**

I		
II		
III		<b>PLAYER</b>
IV		
V		
VI		

(B) SP 

Libero	
L	R

**TEAM NAME**

I		
II		
III		<b>PLAYER</b>
IV		
V		
VI		

CRANE-Libero\_Ctrl.cdr - 09/19/11

(B) SP 

Libero	
L	R

I		
II		
III		
IV		
V		
VI		

(A) SP 

Libero	
L	R

I		
II		
III		
IV		
V		
VI		

AorB 

Libero	
L	R

I							
II							
III		<b>LEFT</b>					
IV							
V							
VI							

AorB 

Libero	
L	R

I							
II							
III			<b>MIDDLE</b>				
IV							
V							
VI							

AorB 

Libero	
L	R

 SP

I							
II							
III				<b>RIGHT</b>			
IV							
V							
VI							

Enter the Libero number(s) in the Libero boxes and starting players' numbers in the SP column.  
 When the Libero enters, write L or R, showing which Libero entered, next to the exiting player's number.  
 When the Libero leaves, write the returning player's number or L or R if replaced by the other Libero.  
 If a regular sub occurs, slash the player number and enter the new number.  
 If a libero serves, place a triangle around the Roman numeral for that service position.

IV	6	L	6	L	6	21	L	R	21	6
----	---	---	---	---	---	----	---	---	----	---

# ASSISTANT SCORER AND LIBERO CONTROL SHEET PROCEDURES

## A1 TERMINOLOGY

### A1.1 ACTING LIBERO

The Libero on the court.

### A1.2 SECOND LIBERO

The Libero (if two (2) are designated) that is not on the court.

### A1.3 THE L LIBERO

The Libero recorded on the line-up sheet in the first Libero box.

### A1.4 THE R LIBERO

The second Libero, if recorded on the line-up sheet, in the second Libero box.

### A1.5 RALLY

A sequence of playing actions from the moment of the service hit by the server until the ball is out of play.

### A1.6 COMPLETED RALLY

The sequence of playing actions which results in the award of a point. This includes the award of a penalty and loss of service for service hit made after the time limit.

### A1.7 LIBERO REPLACEMENT

A1.7.1 When the Libero replaces a regular player in the back row.

A1.7.2 When the Acting Libero is replaced on the court by the:

- a. The regular replacement player in that position;  
The second Libero.

## A2 LIBERO REPLACEMENTS

### A2.1 CHARACTERISTICS

A2.1.1 Libero replacements:

- a. Are not counted as substitutions.
- b. Are unlimited.
- c. Can take place:
  - 1) At the start of each set;

- 2) While the ball is out of play and before the whistle for service.

## A2.2 LIMITATIONS

- A2.2.1 At the start of each set, the Libero may not enter the court until authorized by the 2nd referee.
  - a. Either Libero, **L** or **R**, may enter the set.
- A2.2.2 The regular replacement player must be the regular player originally replaced by the Libero.
- A2.2.3 There must be a completed rally between two Libero replacements **unless**:
  - a. A penalty causes the team to rotate and the Libero moves to position four (left front)  
The Acting Libero becomes unable to play;
  - b. In one rotation, the Libero can replace the player in position one (right back) and serve the next rally.

## A2.3 ILLEGAL REPLACEMENTS

- A2.3.1 An illegal Libero replacement can involve (amongst others):
  - a. No completed rally between replacements;  
The Libero being replaced by a player other than:
    - 1) The second Libero;
    - 2) The regular replacement player (the regular player originally replaced by the Libero).
- A2.3.2 Illegal Libero replacements are considered in the same way as an illegal substitution.
  - a. If noticed before the next rally:
    - 1) It is corrected by the referees;
    - 2) The team is sanctioned for delay.
  - Is noticed after the service hit:
    - 3) Treated the same as an illegal substitution.

## A3 LIBERO RE-DESIGNATIONS

### A3.1 TEAMS WITH ONE LIBERO

- A3.1.1 If this Libero becomes unable to play:
- The coach or captain may re-designate, as Libero, any other player (replacement player excepted) not on the court at the moment of the re-designation.

## A4 ASSISTANT SCORER DUTIES

### A4.1 USE THE LIBERO CONTROL SHEET TO:

- A4.1.1 Identify each team's designated Liberos;
- A4.1.2 Verify that Libero replacements are legal;
- A4.1.3 Record Libero replacements;
- A4.1.4 Record substitutions;
- A4.1.5 Verify that the correct players return to court after time outs and after the court change in deciding sets;
- A4.1.6 Identify which Libero (L or R) is the Acting Libero.

### A4.2 COMMUNICATE WITH SCORER AND 2ND REFEREE

- A4.2.1 Immediately notify 2nd referee if an illegal Libero replacement occurs.
- If possible, as soon as it occurs to prevent further consequences;
  - As soon as the replacement is discovered to be illegal.

#### A4.2.2 After time outs and the court change in deciding sets:

- Signal the 2nd referee whether each team's Libero is on or off the court.  
Using the hand corresponding to the court (**left** hand for the left court, **right** hand for the right court):
  - If the Libero is **on the court**, hold the hand over the table with the palm facing down;
  - If the Libero is **off the court**, hold the hand up with the palm facing the shoulder.

#### A4.2.3 When requested by the 2nd referee:

- Identify which Libero (**L** or **R**) is on the court for a team that has two (2) designated Liberos.

### A4.3 GAME CAPTAIN TRACKING

A4.3.1 It is not required to track the game captain or changes of the game captain.

## A5 USING THE LIBERO CONTROL SHEET

### A5.1 TEAM NAMES AND LINE-UPS

A5.1.1 Record the team names next to the appropriate **A** and **B** designations for **Sets 1** and **2** (consistent with the score sheet).

A5.1.2 Record the starting line-up for each team in the Starting Players column (**SP**).

A	SP	Libero		COBRAS
		L	R	
I	15			
II	8			
III	10			
IV	47			
V	23			
VI	2			

### A5.2 LIBEROS

A5.2.1 When a team designates two Liberos on the **Set 1 Line-up Sheet** they are designated for the match.

a. Record the two numbers in the **L** & **R** Libero boxes for all sets.

Set 1		Libero	
A	SP	L	R
		11	3

Set 2		Libero	
A	SP	L	R
		11	3

A5.2.2 When a team designates one Libero on the **Set 1 Line-up Sheet**:

- The team may designate zero or one Libero for each remaining set of the match;
- Record the number in the **L** box for Set 1 only.
- Draw an 'X' in the **R** box for all non-deciding sets.
- Before each set, record the Libero number (from the **Line-up Sheet**) or an 'X' (if zero Libero is designated) in **L** box for this set only.

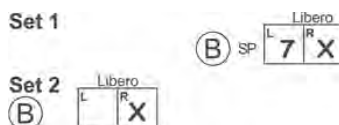

A5.2.3 When a team designates zero Libero on the Set 1 Line-up Sheet:

- The team may designate zero or one Libero for each remaining set of the match;
- Draw an 'X' in the L box for Set 1 only.
- Draw an 'X' in the R box for all sets.
- Before each set, record the Libero number (from the Line-up Sheet) or an 'X' (if zero Libero is designated) in L box for this set only.

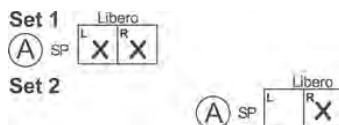

### A5.3 RECORDING LIBERO REPLACEMENTS

A5.3.1 **Slashes are never used to record Libero replacements.**

A5.3.2 Write an L or R next to the replaced regular player number or Acting Libero letter to designate which Libero entered the court as a replacement.

A5.3.3 When the replacement regular player returns to the court:

- Write the player number next to the L or R.

		Libero	
		L	R
(A) SP		11	3
I	15	L 15	
II	8		
III	6		
IV	47	L R 47	
V	23		
VI	2		

### A5.4 RECORDING SUBSTITUTIONS

A5.4.1 Slash through the exiting player number.

A5.4.2 Record the substitute player number immediately to the right.

		LIBERO	
(A)	SP	L 11	R 3
I	15	L 15	
II	8		
III	6		
IV	47	L R	47
V	<del>23</del>	23	
VI	2		

### A5.5 LIBERO SERVING

A5.5.1 Record the first time a Libero serves in each set.

- a. Draw a triangle around the position number (the Roman numeral) in the Service Order area of the **Libero Control Sheet**.

		Libero	
(B)	SP	L 9	R X
I	2		
II	8	L	
III	10		

### A5.6 LIBERO RE-DESIGNATION

A5.6.1 When the Libero is re-designated;

- a. Circle the appropriate number in the **Libero** box:  
Record the number of the new re-designated Libero next to or above the circled number(s).

A5.6.2 When two Liberos were designated at the start of the match:

- a. Repeat these actions for the remaining non-deciding sets in the match.

		10 Libero	
(B)	SP	(9)	(4) EA
I	2		
II	8		
III	<del>6</del>	10 6	
IV	32		
V	23	L	23
VI	<del>7</del>	14 7	

## A5.7 DECIDING SET PREPARATION when a court change will occur

### A5.7.1 Information

- a. For the team starting on the **left** court:
  - 1) Record all information on both the **LEFT** and **RIGHT** sections.  
For the team starting on the **right** court:
  - 2) Record all information on the **MIDDLE** section.

### A5.7.2 After the Coin Toss:

- a. Record the team **A/B** designation from set 1 in the **A/B** circle:
  - 1) For a one (1) set playoff,  
The team starting on the **left** court will be designated Team **A**;  
The team starting on the **right** court will be designated Team **B**;
- b. Record the Team Name.

### A5.7.3 After the Line-Ups Are Submitted:

- a. Record the starting Line-Ups;
- b. Record the Libero numbers.

## A5.8 DECIDING SET with a court change – LIBERO SERVING

### A5.8.1 The first time the Libero serves in the set:

- a. Record a triangle around the appropriate position number in the Service Order area.

### A5.8.2 Libero serving on team starting on **left** court:

- a. If the first serve occurs before the court change, record the triangle on both the **LEFT** and **RIGHT** sections.
- b. If the first serve occurs after the court change, record the triangle on the **RIGHT** section only.

## A5.9 DECIDING SET with a court change – SUBSTITUTIONS

### A5.9.1 For the team beginning on the **right** court and finishing on the **left** court:

- a. Record all substitutions on the **MIDDLE** section only.

### A5.9.2 For the team beginning on the **left** court and finishing on the **right** court:



- a. **Before the court change:**
  - 1) Record all substitutions, **as they occur**, on the **LEFT** section;
  - 2) Record all substitutions, **as they occur**, on the **RIGHT** section.
- b. **After the court change:**
  - 3) Record all substitutions on the **RIGHT** section **only**.

#### A5.10 DECIDING SET with a court change – LIBERO REPLACEMENTS

A5.10.1 For the team beginning on the right court and finishing on the left court:

- a. Record all replacements on the **MIDDLE** section.

A5.10.2 For the team beginning on the left court and finishing on the right court:

- a. Before the court change:
  - 1) Record all replacements on the **LEFT** section;
- b. After the court change:
  - 1) Record all replacements on the **RIGHT** section **only**.  
Substitutions and replacements before court change

#### A5.11 AT COURT CHANGE

A5.11.1 No Libero replacements can occur until after the court change.

A5.11.2 If the Libero is on the court for the team changing courts (from **left** to **right** court):

Record the letter of the Acting Libero from the **LEFT** section onto the **RIGHT** section, in the corresponding position.

#### A5.12 AFTER COURT CHANGE

A5.12.1 The **LEFT** section is no longer used. A5.12.2 For the team now on the left court:

- a. Record all substitutions and replacements on the **MIDDLE** section **only**.

A5.12.3 For the team now on the **right** court:

- a. Record all substitutions and replacements on the **RIGHT** section **only**.

## A5.13 POST MATCH PROCEDURES

A5.13.1 Before leaving the Scorer Table:

- a. Remove all personal items;  
Discard all trash.

# TWO SET SCORE SHEET

Date	8:00a - 08:00
Court	12:00p - 14:00
Time	3:00p - 15:00

TEAM	MATCH WINNER	Sets	W	L
TEAM	SET 1 RESULTS	Score		
Winning				
Losing				
TEAM	SET 2 RESULTS	Score		
Winning				
Losing				

SIGNATURES

1st Referee

OFFICIALS PRINTED NAMES

1st

2nd

Scorer

Work Team

Region

D=Delay A=Asst Coach  
IMPROPER REQUEST  
N=No Play  
C=Coach M=Manager  
TEAM (A) : TEAM (B)

W I B L D SET SCORE  
Match Point Error Disc

SANCTIONS

REMARKS

© 2023 USA Volleyball, Deciding Set Scoresheet

Name of the Competitor:		Pool Phase:	
City, State:		Match N°:	
Hall:		Level:	
Division:	Men <input type="checkbox"/> Women <input type="checkbox"/> CoEd <input type="checkbox"/>		
Category:	Adult <input type="checkbox"/> Junior <input type="checkbox"/>		

Set	Loser Team				Winner Team				Set 1				
	I	II	III	IV	I	II	III	IV					
Order	Points	1 13 25	2 14 26	3 15 27	4 16 28	1 13 25	2 14 26	3 15 27	4 16 28	VI			
	Points	5 17 29	6 18 30	7 19 31	8 20 32	9 21 33	10 22 34	11 23 35	12 24 36	V			
	Time	OUTS											
	Score at Substitution												
	Service Rounds	1	4	1	4	1	4	1	4	1	4		
	Substitutions	1	2	3	4	5	6	7	8	9	10	11	12

Set	Loser Team				Winner Team				Set 2				
	I	II	III	IV	I	II	III	IV					
Order	Points	1 13 25	2 14 26	3 15 27	4 16 28	1 13 25	2 14 26	3 15 27	4 16 28	VI			
	Points	5 17 29	6 18 30	7 19 31	8 20 32	9 21 33	10 22 34	11 23 35	12 24 36	V			
	Time	OUTS											
	Score at Substitution												
	Service Rounds	1	4	1	4	1	4	1	4	1	4		
	Substitutions	1	2	3	4	5	6	7	8	9	10	11	12



Diagram 6



# LIBERO CONTROL SHEET

Libero  
 (A) SP 

L	R
---	---

I		
II		
III		
IV		
V		
VI		

Libero  
 (B) SP 

L	R
---	---

I		
II		
III		
IV		
V		
VI		

CRANE-Libero\_Ctrl.cdr - 09/19/11

Libero  
 (B) SP 

L	R
---	---

I		
II		
III		
IV		
V		
VI		

Libero  
 (A) SP 

L	R
---	---

I		
II		
III		
IV		
V		
VI		

AorB  
 (O) SP 

L	R
---	---

I		
II		
III		
IV		
V		
VI		

AorB  
 (O) SP 

L	R
---	---

I		
II		
III		
IV		
V		
VI		

AorB  
 (O) SP

I		
II		
III		
IV		
V		
VI		

Enter the Libero number(s) in the Libero boxes and starting players' numbers in the SP column. When the Libero enters, write L or R, showing which Libero entered, next to the exiting player's number. When the Libero leaves, write the returning player's number or L or R if replaced by the other Libero. If a regular sub occurs, slash the player number and enter the new number. If a libero serves, place a triangle around the Roman numeral for that service position.

IV	6	L	6	L	6	21	L	R	21	6
----	---	---	---	---	---	----	---	---	----	---

Scoring Examples

NON-DECIDING SET

INFORMATION	ACTION
<b>USE BLUE/BLACK INK</b>	
<p><b>E1 PRE-MATCH</b>  <b>Name:</b> 2017 USAV Open Championships   <b>City, St:</b> Jefferson City, Mo.  <b>Hall:</b> Jeff City Truman Hall   <b>Date:</b> June 7, 2017  <b>Match Time:</b> 4:10 PM  <b>Court:</b> 15   <b>Set 1</b>  <b>Match Info:</b> Adult Men's 60s  <b>Pool:</b> R2M6P4  <b>Match:</b> 3   <b>Teams:</b>  <u>Wizards of Emerald City</u>  <u>Lost Boys of Neverland</u>   <b>1<sup>st</sup> Referee:</b> Jane Doe  <b>2<sup>nd</sup> Referee:</b> Jax Smith  <b>Scorer:</b> Sam Uncle  <b>Work Team:</b> Tin Men  <b>Region:</b> OZ</p>	<p style="text-align: center;"><b>SCORER</b></p> <p><b>If not pre-printed,</b></p> <ol style="list-style-type: none"> <li>Record all <b>HEADINGS</b>.</li> <li>Record <b>1</b> in Set box.</li> <li>Record <b>OFFICIALS' PRINTED NAMES</b>.</li> <li>Record <b>Work Team</b> and <b>Region</b> two-letter code.</li> </ol> <p><b>Notes and Hints</b></p> <p>Use all <b>CAPITAL LETTERS</b>;</p> <p>In <b>vs</b> box:  Use <b>TEAM'S FULL NAMES</b>;</p> <p>All officials' names are recorded as <b>LAST NAME, FIRST NAME</b>;</p> <p><b>Shortened Team Names:</b>  <b>WIZARDS</b> and <b>LOST BOYS</b>,</p>
<p><b>E2 RESULTS OF COIN TOSS</b></p> <p><b>LOST BOYS</b>  Receiving from <b>left</b> court;  <b>WIZARDS</b>  Serving from <b>right</b> court;</p> <p><b>NOTE:</b> Teams alternate courts for all non-deciding sets.</p>	<p style="text-align: center;"><b>SCORER</b></p> <ol style="list-style-type: none"> <li>Record: <ol style="list-style-type: none"> <li><b>LOST BOYS</b> in Team Info section on left side.</li> <li><b>WIZARDS</b> in Team Info section on right side.</li> </ol> </li> </ol> <p><b>If not pre-printed,</b></p> <ol style="list-style-type: none"> <li>Record in <b>A/B</b> circles: <ol style="list-style-type: none"> <li><b>A</b> next to <b>LOST BOYS</b>;</li> <li><b>B</b> next to <b>WIZARDS</b>.</li> </ol> </li> <li>Record this information on all non-deciding set score sheets. <ol style="list-style-type: none"> <li><b>Alternate Sides of SCORE SHEET</b> for Each Set.</li> </ol> </li> </ol>

**INFORMATION**

**ACTION**

<p><b>E2 RESULTS OF COIN TOSS</b> Continued</p> <p><b>LOST BOYS</b> Receiving from <b>left</b> court;</p> <p><b>WIZARDS</b> Serving from <b>right</b> court;</p>	<p><b>SCORER</b></p> <p>4. Record <b>X</b> through: a. The <b>®</b> for <b>LOST BOYS</b>; b. The <b>®</b> for <b>WIZARDS</b>.</p> <p>5. Record <b>X</b> in <b>LOST BOYS Service Rounds</b>, column <b>I</b>, box <b>1</b>.</p> <p>6. Record serving and receiving information on all non-deciding set score sheets.</p> <p><b>Serve and Receive Remain on Same Side of SCORE SHEET.</b></p> <p><b>ASSISTANT SCORER</b> <b>Will Record Information on LIBERO CONTROL SHEET</b></p> <p><b>For all non-deciding sets:</b></p> <p>7. Record <b>LOST BOYS</b> next to Libero boxes for team <b>A</b>; 8. Record <b>WIZARDS</b> next to Libero boxes for team <b>B</b>;</p>																								
<p><b>E3 ROSTERS</b></p> <p><b>LOST BOYS: 9</b> Team Captain;</p> <p><b>WIZARDS: No</b> captain indicated;</p>	<p><b>SCORER</b></p> <p><b>Above LOST BOYS</b></p> <p>1. Record <b>9</b> in <b>CAPTAIN</b> box.</p> <p><b>Above WIZARDS</b></p> <p>2. Record <b>X</b> in <b>CAPTAIN</b> box.</p>																								
<p><b>E4 LOST BOYS LINE-UP SHEET</b></p> <table border="1" data-bbox="145 1015 502 1396"> <tr> <td colspan="2"><b>SET 1</b></td> <td>LIBERO N°</td> </tr> <tr> <td colspan="2">LINE-UP SHEET</td> <td></td> </tr> <tr> <td>TEAM <b>LOST BOYS</b></td> <td><b>11</b></td> <td><b>X</b></td> </tr> <tr> <td>IV</td> <td>III</td> <td>II</td> </tr> <tr> <td><b>47</b></td> <td><b>10c</b></td> <td><b>8</b></td> </tr> <tr> <td>V</td> <td>VI</td> <td>I</td> </tr> <tr> <td><b>23</b></td> <td><b>2</b></td> <td><b>15</b></td> </tr> <tr> <td colspan="3" style="text-align: center;">SERVICE</td> </tr> </table> <p style="text-align: center;">COACH SIGNATURE</p> <p style="text-align: center;"><i>Lostboys Boss</i></p> 	<b>SET 1</b>		LIBERO N°	LINE-UP SHEET			TEAM <b>LOST BOYS</b>	<b>11</b>	<b>X</b>	IV	III	II	<b>47</b>	<b>10c</b>	<b>8</b>	V	VI	I	<b>23</b>	<b>2</b>	<b>15</b>	SERVICE			<p><b>SCORER</b></p> <p><b>Next to LOST BOYS</b> In Libero# boxes:</p> <p>1. Record: a. <b>11</b> in first box; b. <b>X</b> in second box.</p> <p><b>For LOST BOYS: On all remaining LINEUP SHEETS and all remaining non-deciding set score sheets:</b></p> <p>2. Record <b>X</b> in second box.</p> <p><b>Below LOST BOYS</b></p> <p>3. Record line-up in <b>SERVICE ORDER</b> section.</p>
<b>SET 1</b>		LIBERO N°																							
LINE-UP SHEET																									
TEAM <b>LOST BOYS</b>	<b>11</b>	<b>X</b>																							
IV	III	II																							
<b>47</b>	<b>10c</b>	<b>8</b>																							
V	VI	I																							
<b>23</b>	<b>2</b>	<b>15</b>																							
SERVICE																									

**INFORMATION**

**ACTION**

**E4 LOST BOYS**  
**LINE-UP SHEET**  
 Continued

SET 1 LINE-UP SHEET		LIBERO Nº
TEAM <b>LOST BOYS</b>		<b>11 X</b>
IV <b>47</b>	III <b>10c</b>	II <b>8</b>
V <b>23</b>	VI <b>2</b>	I <b>15</b>
SERVICE COACH SIGNATURE		

 *Lostboys Boss*

**SCORER**

**Above LOST BOYS**

4. Record captain:  
 a. **10** in **CAPTAIN** circle,  
**ASSISTANT SCORER**

**For LOST BOYS**

For Set 1 only:

5. Record Liberos:  
 a. **11** in **L** box;  
 b. **X** in **R** box.

On all non-deciding sets:

6. Record **X** in **R** box.  
 7. Record the starting line-up  
 in the **SP** column.

**Note: LOST BOYS can choose a different Libero for each set.**

**E5 WIZARDS**  
**LINE-UP SHEET**

SET 1 LINE-UP SHEET		LIBERO Nº
TEAM <b>WIZARDS</b>		<b>6c 20</b>
IV <b>14</b>	III <b>1</b>	II <b>3</b>
V <b>5a</b>	VI <b>7</b>	I <b>9</b>
SERVICE COACH SIGNATURE		

 *Wizard Leader*

The Libero **6** is the game captain,  
 when on the court.

The **alternate game** captain is **5** and  
 will assume the duties of the game  
 captain when Libero **6** is not on the  
 court.

**SCORER**

**Next to WIZARDS**

1. Record, in **Libero#** boxes:  
 a. **6** in first box;  
 b. **20** in second box.

For WIZARDS: On all remaining  
 LINEUP SHEETS and all remaining  
 non-deciding set score sheets:

2. Record:  
 a. **6** in first box;  
 b. **20** in second box.

**Below WIZARDS**

3. Record line-up in the  
**SERVICE ORDER** section.

**Above WIZARDS**

4. Record team captains:  
 a. **6** in **CAPTAIN** circle;  
 b. **5** in first slot.

**ASSISTANT SCORER**

**For WIZARDS**

5. Record Liberos **for Set 1**:  
 a. **6** in **L** box;  
 b. **20** in **R** box;

On all non-deciding sets:

6. Record:  
 a. **6** in **L** box;  
 b. **20** in **R** box;



**INFORMATION**

**ACTION**

L		R			L		R		
(A)	⊗	11	X	<b>LOST BOYS</b>	(B)	⊗	6	20	<b>WIZARDS</b>
I		15			I		9		
II		8			II		3		
III		10			III		1		
IV		47			IV		14		
V		23			V		5		
VI		2			VI		7		

**E6 RECOMMENDED SUBSTITUTION PROCEDURE**

**ROSTERS ARE NOT USED AT ALL EVENTS**

**Required For National Scorers**

4	3	2	1	Time Outs	Time Outs	1	2	3	4
1	2	5		<b>LOST BOYS</b>	<b>WIZARDS</b>	2	5		
1	3	6		2	2	3	6		
9 17					4 22				

**SCORER**

After comparing the rosters and line-up sheets:

The **Legal Substitutes** are:

**LOST BOYS: 9, 17**

**WIZARDS: 4, 22**

1. Record each team's legal substitutes in **Legal Substitutes** section.
2. Use recorded **Legal Substitutes** to confirm the substitute (incoming) is legal.

**E7 CHECKING LINE-UPS**

While checking the **WIZARDS** line-up, the 2<sup>nd</sup> referee and scorer notice that **WIZARDS 4** is on the court instead of **14**.

**WIZARDS 14** is **NOT** present courtside.

**WIZARDS** request a substitution **4** for **14**.

**SCORER**

**For WIZARDS**

In **Legal Substitutes** section:

1. Confirm substitute is legal;
2. Slash through **4** to indicate that **4** has entered the court;

In **Score at Substitutions** column **IV**, first row under **14**:

3. Record **4** in left box;
4. Record **0:0** (score) in right box;

In **Substitutions** row:

5. Slash through **1**.

**ASSISTANT SCORER**

In **WIZARDS PLAYER** section:

6. Slash through **14**.
7. Record **4** next to **14**.

**INFORMATION**

**ACTION**

<p><b>E8 LIBERO REPLACEMENT</b></p> <p>After 2<sup>nd</sup> referee and scorer check <b>WIZARDS</b> line-up, <b>WIZARDS</b> Libero <b>6</b> replaces <b>7</b>.</p> <p>After 2<sup>nd</sup> referee and scorer check <b>LOST BOYS</b> line-up, <b>LOST BOYS</b> Libero <b>11</b> replaces <b>23</b>.</p>	<p><b>ASSISTANT SCORER</b></p> <p>In <b>WIZARDS PLAYER</b> section:</p> <ol style="list-style-type: none"> <li>Record <b>L</b> next to <b>7</b>;             <ol style="list-style-type: none"> <li><b>Do not</b> slash through <b>7</b>.</li> </ol> </li> </ol> <p>In <b>LOST BOYS PLAYER</b> section:</p> <ol style="list-style-type: none"> <li>Record <b>L</b> next to <b>23</b>;             <ol style="list-style-type: none"> <li><b>Do not</b> slash through <b>23</b>.</li> </ol> </li> </ol>
<p><b>E9 DELAY WARNING</b></p> <p>After 2<sup>nd</sup> referee checks <b>LOST BOYS</b> line-up, <b>LOST BOYS 2</b> goes to the bench to fix jersey.</p> <p>1<sup>st</sup> referee issues a delay warning.</p>	<p><b>SCORER</b></p> <p>In first row of <b>SANCTIONS</b> box:</p> <ol style="list-style-type: none"> <li>Record:             <ol style="list-style-type: none"> <li><b>D</b> in <b>W Warn</b> column;</li> <li><b>A</b> in <b>A/B</b> column;</li> <li><b>1</b> in <b>SET</b> column;</li> <li><b>0:0</b> in <b>SCORE</b> column.</li> </ol> </li> </ol>
<p><b>E10 LINE-UP CHECKS DONE</b></p> <p>2<sup>nd</sup> referee and scorer have completed line-up checks for both teams.</p>	<p><b>SCORER &amp; ASSISTANT</b></p> <ol style="list-style-type: none"> <li>Make eye contact with 2<sup>nd</sup> referee.</li> <li>Show <b>Ready</b> signal.</li> </ol>
<p><b>E11 FIRST SERVICE</b></p> <p>At 4:10 PM, 1<sup>st</sup> referee beckons for serve.</p>	<p><b>SCORER</b></p> <p>In <b>Start TIME</b> box:</p> <ol style="list-style-type: none"> <li>Record <b>16:10</b>.</li> </ol>
<p><b>USE PENCIL OR BLUE/BLACK INK</b></p>	
<p><b>E12 WIZARDS SERVICE</b></p> <p><b>WIZARDS 9</b> contacts the ball;</p> <p>Ball lands out of bounds;</p>	<p><b>SCORER</b></p> <p>In <b>WIZARDS Service Rounds Column I, Box 1</b>, under <b>9</b>:</p> <ol style="list-style-type: none"> <li>Draw small checkmark (✓) through <b>1</b> in upper right corner;</li> <li>Record Exit Score <b>0</b> in the box.</li> </ol> <p>In <b>LOST BOYS Points</b> column:</p> <ol style="list-style-type: none"> <li>Slash through <u>rally point 1</u>.</li> </ol>
<p><b>E13 LOST BOYS ROTATE</b></p> <p><b>LOST BOYS 23</b> replaces Libero;</p>	<p><b>ASSISTANT SCORER</b></p> <p>In <b>LOST BOYS PLAYER</b> section:</p> <ol style="list-style-type: none"> <li>Record <b>23</b> next to <b>L</b>.             <ol style="list-style-type: none"> <li><b>Do not</b> slash through <b>L</b>.</li> </ol> </li> </ol>

INFORMATION	ACTION
<p><b>E14 LOST BOYS SERVICE</b></p> <p><b>LOST BOYS 8</b> contacts the ball;</p> <p>Wins point; Serves an ace; Wins another point; Serves into net;</p>	<p><b>SCORER</b></p> <p>In <b>LOST BOYS Service Rounds</b> column <b>II</b>, box <b>1</b>, under <b>8</b>:</p> <ol style="list-style-type: none"> <li>1. Draw small checkmark (✓) through <b>1</b> in upper right corner.</li> </ol> <p>In <b>LOST BOYS Points</b> column:</p> <ol style="list-style-type: none"> <li>2. Slash through <b>2</b>;</li> <li>3. Slash through <b>3</b>;</li> <li>4. Slash through <b>4</b>;</li> <li>5. Record Exit Score <b>4</b>.</li> <li>6. Slash through <b>WIZARDS rally point 1</b>.</li> </ol>
<p><b>E15 WIZARDS SERVICE</b></p> <p><b>WIZARDS 3</b> contacts ball;</p> <p><b>LOST BOYS</b> shank ball and lose point; <b>WIZARDS 3</b> serves two aces; <b>WIZARDS</b> win next point on a close lines call;</p> <p><b>LOST BOYS 10</b> complains loudly about call and is given a verbal warning; <b>WIZARDS 3</b> serves a point;</p>	<p><b>SCORER</b></p> <p>In <b>WIZARDS Service Rounds</b> column <b>II</b>, box <b>1</b>, under <b>3</b>:</p> <ol style="list-style-type: none"> <li>1. Draw a small checkmark (✓) through <b>1</b> in the right corner.</li> </ol> <p>In <b>WIZARDS Points</b> column:</p> <ol style="list-style-type: none"> <li>2. Slash through <b>2</b>;</li> <li>3. Slash through <b>3, 4</b>;</li> <li>4. Slash through <b>5</b>;</li> <li>5. No action required;</li> <li>6. Slash through <b>6</b>.</li> </ol>
<p><b>E16 SUBSTITUTION</b></p> <p><b>LOST BOYS</b> substitute <b>17</b> for <b>15</b>;</p>	<p><b>SCORER</b></p> <p>In <b>LOST BOYS Legal Substitute</b> section:</p> <ol style="list-style-type: none"> <li>1. Confirm substitute is legal;</li> <li>2. Slash through <b>17</b>;</li> </ol> <p>In <b>LOST BOYS Score at Substitution</b> row under <b>15</b>:</p> <ol style="list-style-type: none"> <li>3. Record <b>17</b> in left box;</li> <li>4. Record <b>4:6</b> (score) in right box;</li> </ol> <p>In <b>LOST BOYS Substitutions</b> row:</p> <ol style="list-style-type: none"> <li>5. Slash through <b>1</b>.</li> <li>6. Show <b>READY</b> signal.</li> </ol>

## INFORMATION

## ACTION

INFORMATION	ACTION
<b>E16 SUBSTITUTION</b> Continued <b>LOST BOYS</b> substitute 17 for 15;	<b>ASSISTANT SCORER</b> In <b>LOST BOYS PLAYER</b> section: 7. Slash through 15. 8. Record 17 next to 15.
<b>E17 MISCONDUCT WARNING</b> <b>YELLOW CARD</b> <b>LOST BOYS 10</b> continues complaining about ball handling and line calls. The 1 <sup>st</sup> referee issues a Misconduct Warning (Yellow Card).	<b>SCORER</b> In the next <b>SANCTIONS</b> box: 1. Record: a. 10 in W Warn column; b. A in A/B column; c. 1 in SET column; d. 4:6 in SCORE column. 2. Show <b>READY</b> signal.
<b>E18 TIME OUT</b> <b>LOST BOYS</b> take 1 <sup>st</sup> time out.	<b>SCORER</b> In first <b>Time Out</b> box under <b>LOST BOYS Points</b> column: 1. Record 4:6 (score). 2. Show 2 <sup>nd</sup> referee number of time outs taken by each team. At end of time out: 3. Show <b>READY</b> signal.
<b>E19 WIZARDS CONTINUE TO SERVE</b> <b>WIZARDS 3</b> serves into the net.	<b>SCORER</b> 1. Record <b>WIZARDS</b> exit score 6. 2. Record <b>LOST BOYS rally point</b> 5.
<b>E20 SUBSTITUTION</b>  <b>LOST BOYS</b> substitute 9 for 47.	<b>SCORER</b> In <b>LOST BOYS Legal Substitute</b> section: 1. Confirm substitute is legal; 2. Slash through 9; In <b>LOST BOYS Score at Substitution</b> row under 47: 3. Record 9 in left box; 4. Record 5:6 (score) in right box; 5. Notify 2 <sup>nd</sup> referee that the captain is 9. In <b>LOST BOYS Substitutions</b> row: 6. Slash through 2. 7. Show <b>READY</b> signal.

## INFORMATION

## ACTION

INFORMATION	ACTION
<b>E20 SUBSTITUTION</b> <b>Continued</b>  <b>LOST BOYS</b> substitute <b>9</b> for <b>47</b> .	<b>ASSISTANT SCORER</b>  In <b>LOST BOYS PLAYER</b> section: 8. Record <b>9</b> next to <b>47</b> ; a. Slash through <b>47</b> .
<b>E21 LOST BOYS SERVICE</b> <b>LOST BOYS 9</b> contacts the ball; <b>Wrong Server</b> <b>LOST BOYS 10</b> is correct server.	<b>SCORER</b>  1. Notify 2 <sup>nd</sup> referee of the wrong server.  In <b>LOST BOYS Service Rounds</b> column <b>III</b> , box <b>1</b> , under <b>10</b> : 2. <b>Do Not</b> draw small checkmark (✓) through <b>1</b> in upper right corner. 3. Record Exit Score <b>5</b> . 4. Slash through <b>WIZARDS rally point 7</b> .
<b>E22 WIZARDS ROTATE</b>   <b>WIZARDS</b> substitute <b>22</b> for <b>1</b> .      <b>WIZARDS 7</b> replaces Libero.	<b>SCORER</b>  In <b>WIZARDS Legal Substitute</b> section: 1. Confirm substitute is legal; 2. Slash through <b>22</b> ;  In <b>WIZARDS Score at Substitution</b> row under <b>1</b> : 3. Record <b>22</b> in left box; 4. Record <b>7:5</b> (score) in right box;  In <b>WIZARDS Substitutions</b> row: 5. Slash through <b>2</b> . 6. Show <b>READY</b> signal.   <b>ASSISTANT SCORER</b>  In <b>WIZARDS PLAYER</b> section: 7. Slash through <b>1</b> . 8. Record <b>22</b> next to <b>1</b> ; 9. Record <b>7</b> next to <b>L</b> . a. <b>Do not</b> slash through <b>L</b> .
<b>E23 WIZARDS SERVICE</b>   <b>WIZARDS 22</b> contacts the ball.   <b>WIZARDS 22</b> serves five points.	<b>SCORER</b>  In <b>WIZARDS Service Rounds</b> column <b>III</b> , box <b>1</b> , under <b>22</b> : 1. Draw small checkmark (✓) through <b>1</b> in upper right corner.  In <b>LOST BOYS Points</b> column: 2. Slash through <b>8 - 12</b> ;   2. Slash through <b>8 - 12</b> ;   2. Slash through <b>8 - 12</b> ;   2. Slash through <b>8 - 12</b> ;

INFORMATION	ACTION
<p><b>E23 WIZARDS SERVICE</b>  <b>Continued</b>  <b>WIZARDS 22</b> serves and loses the point.</p>	<p style="text-align: center;"><b>SCORER</b></p> <p>3. Record <b>WIZARDS</b> exit score <b>12</b>.  4. Slash through <b>LOST BOYS rally point 6</b>.</p>
<p><b>E24 LIBERO REPLACEMENT</b>  <b>WIZARDS</b> Libero <b>20</b> replaces <b>22</b>.</p>	<p style="text-align: center;"><b>ASSISTANT SCORER</b></p> <p>In <b>WIZARDS PLAYER</b> section:  1. Record <b>R</b> next to <b>22</b>;  a. <b>Do not</b> slash through <b>22</b>.</p>
<p><b>E25 LOST BOYS SERVICE</b>  <b>LOST BOYS 9</b> serves and loses the point.</p>	<p style="text-align: center;"><b>SCORER</b></p> <p>In <b>LOST BOYS Service Rounds</b> column <b>IV</b>, box <b>1</b>, under <b>9</b>:  1. Draw small checkmark (✓) through <b>1</b> in upper right corner.  2. Record <b>LOST BOYS</b> Exit Score <b>6</b>.  3. Slash through <b>WIZARDS rally point 13</b>.</p>
<p><b>E26 WIZARDS SERVICE</b>  <b>WIZARDS 4</b> contacts the serve.    <b>WIZARDS</b> score 2 points.  <b>WIZARDS</b> lose the next rally.</p>	<p style="text-align: center;"><b>SCORER</b></p> <p>In <b>WIZARDS Service Rounds</b> column <b>IV</b>, box <b>1</b>, under <b>4</b>:  1. Draw small checkmark (✓) through <b>1</b> in upper right corner.  In <b>WIZARDS Points</b> column:  2. Slash through <b>14, 15</b>.  3. Record <b>WIZARDS</b> Exit Score <b>15</b>.  4. Slash through <b>LOST BOYS rally point 7</b>.</p>
<p><b>E27 SUBSTITUTION</b>  <b>WIZARDS</b> substitute <b>14</b> for <b>4</b>.</p>	<p style="text-align: center;"><b>ASSISTANT SCORER</b></p> <p>In <b>WIZARDS</b> Score at <b>Substitution</b> row under <b>4</b>:  1. Record <b>14</b> in left box;  2. Record <b>15:7</b> (score) in right box;  In <b>WIZARDS Substitutions</b> row:  3. Slash through <b>3</b>.  4. Show <b>READY</b> signal.  5. Slash through <b>4</b>.  6. Record <b>14</b> next to <b>4</b>.</p>

INFORMATION	ACTION
<p><b>E28 LOST BOYS SERVICE</b></p> <p><b>LOST BOYS 23</b> contacts ball.</p> <p><b>LOST BOYS</b> lose rally.</p>	<p><b>SCORER</b></p> <p>In <b>LOST BOYS Service Rounds</b> column <b>V</b>, box <b>1</b>, under <b>23</b>:</p> <ol style="list-style-type: none"> <li>1. Draw small checkmark (✓) through <b>1</b> in upper right corner.</li> <li>2. Record <b>LOST BOYS</b> Exit Score <b>7</b>.</li> <li>3. Slash through <b>WIZARDS rally point 16</b>.</li> </ol>
<p><b>E29 LIBERO REPLACEMENT</b></p> <p><b>LOST BOYS</b> Libero <b>11</b> replaces <b>23</b>.</p>	<p><b>ASSISTANT SCORER</b></p> <p>In <b>LOST BOYS PLAYER</b> section:</p> <ol style="list-style-type: none"> <li>1. Record <b>L</b> next to <b>23</b>;             <ol style="list-style-type: none"> <li>a. Do not slash through <b>23</b>.</li> </ol> </li> </ol>
<p><b>E30 WIZARDS SERVICE</b></p> <p><b>WIZARDS 5</b> contacts serve.</p> <p><b>WIZARDS</b> lose rally.</p>	<p><b>SCORER</b></p> <p>In <b>WIZARDS Service Rounds</b> column <b>V</b>, box <b>1</b>, under <b>5</b>:</p> <ol style="list-style-type: none"> <li>1. Draw small checkmark (✓) through <b>1</b> in upper right corner.</li> </ol> <p>In <b>WIZARDS Points</b> column:</p> <ol style="list-style-type: none"> <li>2. Record <b>WIZARDS</b> Exit Score <b>16</b>.</li> <li>3. Slash through <b>LOST BOYS rally point 8</b>.</li> </ol>
<p><b>E31 LIBERO REPLACEMENT</b></p> <p><b>LOST BOYS</b> Libero <b>11</b> goes back to serve.</p>	<p><b>ASSISTANT SCORER</b></p> <p>In <b>LOST BOYS PLAYER</b> section:</p> <ol style="list-style-type: none"> <li>1. Record <b>23</b> next to <b>L</b>;             <ol style="list-style-type: none"> <li>a. Do not slash through <b>L</b>.</li> </ol> </li> <li>2. Record <b>L</b> next to <b>2</b>;             <ol style="list-style-type: none"> <li>a. Do not slash through <b>2</b>.</li> </ol> </li> </ol>
<p><b>E32 LIBERO SERVING</b></p> <p><b>LOST BOYS</b> Libero contacts ball.</p>	<p><b>SCORER</b></p> <p>In <b>LOST BOYS SERVICE ORDER</b></p> <ol style="list-style-type: none"> <li>1. Draw a triangle around <b>VI</b>.</li> </ol> <p><b>ASSISTANT SCORER</b></p> <p>On <b>LOST BOYS</b> side:</p> <ol style="list-style-type: none"> <li>2. Draw a triangle around <b>VI</b>.</li> </ol>

**INFORMATION**

**ACTION**

<b>INFORMATION</b>	<b>ACTION</b>
<p><b>E32 LIBERO SERVING</b> <b>Continued</b></p> <p><b>LOST BOYS</b> score two points.</p> <p><b>LOST BOYS</b> lose next rally,</p>	<p><b>SCORER</b></p> <p>In <b>LOST BOYS Service Rounds</b> column <b>VI</b>, box <b>1</b>, under <b>2</b>:</p> <p>3. Draw small checkmark (✓) through <b>1</b> in upper right corner.</p> <p>In <b>LOST BOYS Points</b> column:</p> <p>4. Draw triangle around <b>9, 10</b>.</p> <p>5. Record <b>LOST BOYS</b> Exit Score <b>10</b>.</p> <p>6. Slash through <b>WIZARDS rally point 17</b>.</p>
<p><b>E33 WIZARDS SERVICE</b></p> <p>After the beckon, <b>WIZARDS 4</b> runs into the substitution zone.</p> <p>The 2<sup>nd</sup> referee waves <b>4</b> back without a whistle.</p> <p><b>WIZARDS 7</b> contacts serve.</p> <p><b>WIZARDS</b> win rally.</p> <p><b>Improper Request</b></p> <p>2<sup>nd</sup> referee notifies scorer of the <b>WIZARDS Improper Request</b>.</p>	<p><b>SCORER</b></p> <p>In <b>WIZARDS Service Rounds</b> column <b>VI</b>, box <b>1</b>, under <b>7</b>:</p> <p>1. Draw small checkmark (✓) through <b>1</b> in upper right corner.</p> <p>In <b>WIZARDS Points</b> column:</p> <p>2. Slash through <b>18</b>.</p> <p>In the <b>IMPROPER REQUEST</b> section:</p> <p>3. Draw an <b>X</b> through the <b>TEAM B</b> circle.</p>
<p><b>E34 LOST BOYS TIME OUT</b></p> <p><b>LOST BOYS</b> take 2<sup>nd</sup> time out.</p>	<p><b>SCORER</b></p> <p>In second <b>Time Out</b> box under <b>LOST BOYS Points</b> column:</p> <p>1. Record <b>10:18</b> (score).</p> <p>2. Show 2<sup>nd</sup> referee number of time outs taken by each team.</p> <p>At end of time out:</p> <p>3. Show <b>READY</b> signal.</p>
<p><b>E35 DELAY SANCTION</b></p> <p>After the time out, <b>LOST BOYS</b> take additional time (1 minute) to clean a water spill on the court.</p> <p>The 1<sup>st</sup> referee issues a delay sanction.</p> <p>During the confusion <b>WIZARDS 22</b> goes to the bench and <b>WIZARDS 1</b> enters the court.</p> <p>A <b>WRONG PLAYER</b> is on the court and goes undetected by the 2<sup>nd</sup> referee and scorer.</p>	<p><b>SCORER</b></p> <p>In next row of <b>SANCTIONS</b> box:</p> <p>1. Record in the columns listed:</p> <p>a. <b>D P-Penalty;</b></p> <p>b. <b>A A/B;</b></p> <p>c. <b>1 SET;</b></p> <p>d. <b>10:18 SCORE.</b></p> <p>In <b>WIZARDS Points</b> column:</p> <p>2. Slash and circle delay penalty point <b>19</b>.</p>



INFORMATION	ACTION
<p><b>E36 WIZARDS CONTINUE SERVING</b></p> <p><b>WIZARDS 7</b> serves an ace.  <b>WIZARDS 7</b> serves into the net.</p>	<p style="text-align: center;"><b>SCORER</b></p> <ol style="list-style-type: none"> <li>1. Slash through <b>20</b>.</li> <li>2. Record <b>WIZARDS</b> Exit Score <b>20</b>.</li> <li>3. Slash through <b>LOST BOYS rally point 11</b>.</li> </ol>
<p><b>E37 LOST BOYS SERVICE</b></p> <p><b>LOST BOYS 17</b> contacts ball.</p> <p><b>LOST BOYS</b> score three points.  <b>LOST BOYS</b> lose next rally.</p>	<p style="text-align: center;"><b>SCORER</b></p> <p>In <b>LOST BOYS Service Rounds</b> column I, box <b>2</b>, under <b>17</b>:</p> <ol style="list-style-type: none"> <li>1. Draw small checkmark (✓) through <b>2</b> in upper right corner.</li> </ol> <p>In <b>LOST BOYS Points</b> column:</p> <ol style="list-style-type: none"> <li>2. Slash through <b>12, 13, 14</b>.</li> <li>3. Record <b>LOST BOYS</b> Exit Score <b>14</b>.</li> <li>4. Slash through <b>WIZARDS rally point 21</b>.</li> </ol>
<p><b>E38 EXCEPTIONAL SUBSTITUTION</b></p> <p>During the previous rally, <b>LOST BOYS 10</b> is injured and unable to continue.</p> <p><b>LOST BOYS</b> players on the bench are <b>15, 47</b>.</p> <p>Since both had been in the set, either can be the exceptional substitute.</p> <p>The coach chooses <b>47</b>.</p>	<p style="text-align: center;"><b>SCORER</b></p> <p>In <b>LOST BOYS SERVICE ORDER</b>, column II:</p> <ol style="list-style-type: none"> <li>1. Draw a circle around <b>10</b> to indicate that <b>10</b> is no longer eligible to play for the match.</li> </ol> <p>In the same column, in the first <b>Score at Substitution</b> row:</p> <ol style="list-style-type: none"> <li>2. Record <b>47</b> in left box;</li> <li>3. <b>Do not</b> record the score in the right box.</li> <li>4. Record a remark in the <b>REMARKS</b> section.</li> </ol> <p style="text-align: center;"><b>ASSISTANT SCORER</b></p> <p>In the <b>LOST BOYS PLAYER</b> section:</p> <ol style="list-style-type: none"> <li>5. Draw a circle around <b>10</b>;</li> <li>6. Do not slash through <b>10</b>;</li> <li>7. Record <b>47</b> next to <b>10</b>.</li> </ol>

INFORMATION	ACTION
<p><b>E39 WIZARDS SERVICE</b></p> <p><b>WIZARDS 9</b> contacts the ball.</p> <p><b>WIZARDS 9</b> scores <b>3</b> points.</p> <p>At this point the scorer realizes that <b>WIZARDS 1</b> is on the court with the score sheet having no record of <b>WIZARDS 1</b> re-entering the court.</p>	<p><b>SCORER</b></p> <p>In <b>WIZARDS Service Rounds</b> column I, box 2, under 9:</p> <ol style="list-style-type: none"> <li>1. Draw small checkmark (✓) through 2 in upper right corner.</li> </ol> <p>In <b>WIZARDS Points</b> column:</p> <ol style="list-style-type: none"> <li>2. Slash through <b>22, 23, 24</b>.</li> <li>3. Notify the 2<sup>nd</sup> referee of the illegal player.</li> </ol>
<p><b>E40 REMOVING POINTS</b></p> <p>The 2<sup>nd</sup> referee and scorer discuss the illegal player.</p> <p>After discussion with the 1<sup>st</sup> referee it is determined that <b>WIZARDS 1</b> entered the court during the time out.</p> <p>The score was <b>WIZARDS 18</b> and <b>LOST BOYS 10</b>.</p> <p>The 2<sup>nd</sup> referee instructs the scorer to remove points <b>19</b> through <b>24</b> and to restore one penalty point.</p>	<p><b>SCORER</b></p> <p>In the <b>WIZARDS Points</b> column:</p> <ol style="list-style-type: none"> <li>1. Remove <b>19-24</b>.  <b>If using pencil:</b> <ol style="list-style-type: none"> <li>a. Erase the slashes over <b>19-24</b>.</li> </ol> <b>If using ink and correction tape:</b> <ol style="list-style-type: none"> <li>b. Use tape to cover <b>19-24</b>;</li> <li>c. Reprint <b>19-24</b>.</li> </ol> <b>Otherwise:</b> <ol style="list-style-type: none"> <li>d. Draw an X through <b>19-24</b>.</li> <li>e. Print <b>19-24</b> next to each X.</li> </ol> </li> </ol> <p>Restore one penalty point:</p> <ol style="list-style-type: none"> <li>2. Slash and circle the first available point 19.</li> <li>3. Record a remark in the <b>REMARKS</b> section.</li> <li>4. Record <b>WIZARDS Exit Score 19</b>.</li> <li>5. Record <b>LOST BOYS rally point 15</b>.</li> <li>6. Show the <b>READY</b> signal.</li> </ol>
<p><b>E41 LOST BOYS SERVICE</b></p> <p><b>LOST BOYS 8</b> contacts the ball.</p>	<p><b>SCORER</b></p> <p>In <b>LOST BOYS Service Rounds</b> column II, box 2, under 8:</p> <ol style="list-style-type: none"> <li>1. Draw small checkmark (✓) through 2 in upper right corner.</li> </ol>

INFORMATION	ACTION
<p><b>E41 LOST BOYS SERVICE</b>  <b>Continued</b>  <b>LOST BOYS</b> score two points.  <b>LOST BOYS</b> lose the next rally.</p>	<p><b>SCORER</b>            In <b>LOST BOYS Points</b> column:            1. Slash through <b>16, 17</b>.            2. Record <b>LOST BOYS</b>            Exit Score <b>17</b>.            Slash through <b>WIZARDS</b>  <i>rally point 20.</i></p>
<p><b>E42 WIZARDS SERVICE</b>    <b>WIZARDS 3</b> contacts the ball.    <b>WIZARDS 3</b> serves 5 points to end the set.</p>	<p><b>SCORER</b>            In <b>WIZARDS Service Rounds</b> column  <b>II</b>, box <b>2</b>, under <b>3</b>:            1. Draw small checkmark (✓)            through <b>2</b> in upper right            corner.            In <b>WIZARDS Points</b> column:            2. Slash through <b>21-25</b>.            3. Record <b>WIZARDS</b>            Exit Score <b>25</b>.</p>
<b>USE BLUE/BLACK INK</b>	
<p><b>E43 SET END TIME</b>              The set ends at 4:42 PM.</p>	<p><b>SCORER</b>            In the <b>End TIME</b> box:            1. Record <b>16:42</b>.</p>

**SCORER**  
**END OF SET PROCEDURES**

**E44 FINAL EXIT SCORES**

In the **SERVICE ROUNDS** section:

1. Circle final **Exit Scores** for each team:
  - a. **LOST BOYS**      **17**;
  - b. **WIZARDS**      **25**.

**E45 SET RESULTS**

In **SET RESULTS** box:

1. Record teams (Name and Score):
  - a. **Winning**      **WIZARDS**      **25**;
  - b. **Losing**      **LOST BOYS**      **17**.

**E46 POINTS COLUMN:**

1. Cancel all unused points using the **T-Bar** method.

**NOTE:** Draw a separate **T-Bar** through each column.

**E47 SCORE SHEET REVIEW**

1. Examine score sheet for completeness and accuracy:
  - a. **Set** number is printed (if not pre-printed);
  - b. **Start** and **End TIMES**;
  - c. Number of substitutions match in all areas;
  - d. Last point recorded in **POINTS COLUMN**;
  - e. Last exit scores entered and circled;
  - f. All unused points in **POINTS COLUMN** are cancelled using **T-Bars**;
  - g. The correct teams and scores are listed in the **RESULTS** section.

**E48 SCORER SIGNATURE**

In the **SIGNATURES** box:

1. Sign the score sheet when complete and accurate.
  - a. For one-up score sheets after each set;
  - b. For two-up score sheets after both sets.

**SCORER**  
**NEXT SET SCORE SHEET PREPARATION PROCEDURES**

**E49 RECORD INFORMATION FROM PREVIOUS SCORE SHEETS**

The 2-up score sheet will have this information recorded once before the first set of each NEW 2-up score sheet begins.

**If not pre-printed**

1. Copy all information from **HEADINGS** section.
2. Copy all information in the **SANCTIONS** section.
3. Copy all information in the **IMPROPER REQUEST** section.
4. Copy all pertinent information in the **REMARKS** section:
  - a. Any information which affects the playing of this set such as exceptional substitutions, Libero re-designations.
5. Copy all information in the **OFFICIALS** section

**Notes:**

Team A from Set 1 remains team A for the entire match.

Teams switch courts for each non-deciding set.

For the deciding set, a coin toss is used to determine starting court for the teams.

6. Record Team Names on correct side of score sheet
7. If not pre-printed, record **A, B** in the correct **A/B** circles.
8. Record **Libero#** boxes:

**If team had designated zero or one Libero in the previous set:**

- a. Draw an 'X' in the right slot of the **Libero#** box for that team.

**If team had designated two Liberors in the previous set:**

- b. Copy all **Libero#** box information.

**FINISHED**

**COMPLETED EXAMPLE LIBERO CONTROL SHEET**

(A) sp		Libero		(B) sp		Libero	
		L 11	R X			L 6	R 20
<b>LOST BOYS</b>				<b>WIZARDS</b>			
I	<del>18</del>	17		I	9		
II	8			II	3		
III	10	47		III	<del>22</del>	R	
IV	<del>9</del>	9		IV	<del>14</del>	14	
V	23	L 23 L 23		V	5		
VI	2	L		VI	7	L 7	



Diagram 7

# DECIDING SET SCORE SHEET

1:00p = 13:00  
2:00p = 14:00  
3:00p = 15:00

Court \_\_\_\_\_  
Time \_\_\_\_\_

City, State: \_\_\_\_\_

Hall: \_\_\_\_\_

Division: Men  Women  CoEd

Category: Adult  Junior

Pool Phase: \_\_\_\_\_ Match N': \_\_\_\_\_

Level: \_\_\_\_\_

VS

TEAM MATCH WINNER SPTS W L

TEAM SET RESULTS Score

Winning \_\_\_\_\_

Losing \_\_\_\_\_

Scorer \_\_\_\_\_

1st Referee \_\_\_\_\_

2nd \_\_\_\_\_

Scorer \_\_\_\_\_

Work Team \_\_\_\_\_ Region \_\_\_\_\_

SIGNATURES \_\_\_\_\_

OFFICIALS PRINTED NAMES \_\_\_\_\_

1st \_\_\_\_\_

2nd \_\_\_\_\_

REMARKS \_\_\_\_\_

**USA Volleyball**

**OFFICIAL SCORESHEET**

Deciding Set Scoresheet

D=Delay A=Asst Coach IMPROPER REQUEST

#=Player T=Trainer TEAM(A) : TEAM(B)

C=Coach M=Manager

W	P	E	D	Ⓢ	Ⓣ	SET	SCORE
Warm	Penalty	Expel	Diso	Ⓢ	Ⓣ		

Start	Team		Liberal		Points		Liberal		Team		Points		Team		Points		Team		Set	
	I	II	III	IV	V	VI	I	II	III	IV	V	VI	I	II	III	IV	V	VI		
Order	1	2	3	4	5	6	7	8	9	10	11	12	13	14	15	16	17	18	19	20
Score at Substitution	1	2	3	4	5	6	7	8	9	10	11	12	13	14	15	16	17	18	19	20
Service Rounds	1	2	3	4	5	6	7	8	9	10	11	12	13	14	15	16	17	18	19	20
Substitutions	1	2	3	4	5	6	7	8	9	10	11	12	13	14	15	16	17	18	19	20

© 2023 USA Volleyball, Deciding Set Scoresheet

DECIDING SET

(Step by Step)

INFORMATION		ACTION
<b>USE BLUE/BLACK INK</b>		
<b>D1</b>	<b>PRE-MATCH</b>	<b>SCORER</b>
<b>Name:</b>	2017 USAV Open Championships	<b>If not pre-printed,</b>
<b>City, St:</b>	Jefferson City, Mo.	1. Record all <b>HEADINGS</b> .
<b>Hall:</b>	Jeff City Truman Hall	2. Record <b>3</b> in <b>Set</b> box.
<b>Date:</b>	June 7, 2017	3. Record <b>OFFICIALS'</b>
<b>Match Time:</b>	4:10 PM	<b>PRINTED NAMES</b> .
<b>Court:</b>	15	4. Record <b>Work Team</b> and
<b>Set 1</b>		<b>Region</b> two-letter code.
<b>Match Info:</b>	Adult Men's 60s	5. Copy all <b>SANCTIONS</b> and
<b>Pool:</b>	R2M6P4	any <i>pertinent</i> <b>REMARKS</b> from
<b>Match:</b>	3	<b>Set 1</b> and <b>Set 2</b> to the <b>Set 3</b>
<b>Teams:</b>		score sheet.
<u>Wizards of Emerald City</u>		It is not necessary to copy the
<u>Lost Boys of Neverland</u>		removal of points remark from
<b>1<sup>st</sup> Referee:</b>	Jane Doe	<b>Set 1</b> to the <b>Set 3</b> score sheet.
<b>2<sup>nd</sup> Referee:</b>	Jax Smith	
<b>Scorer:</b>	Sam Uncle	<b>Notes and Hints</b>
<b>Work Team:</b>	Tin Men	Use all <b>CAPITAL LETTERS</b> ;
<b>Region:</b>	OZ	In vs box:
<b>WIZARDS</b>	won set 1 25:17	Use <b>TEAM'S FULL NAMES</b> ;
<b>LOST BOYS</b>	won set 2 25:20	All officials' names are recorded as
There were no <b>SANCTIONS</b> or		<b>LAST NAME, FIRST NAME</b> ;
pertinent <b>REMARKS</b> in set 2.		<b>Shortened Team Names:</b>
		<b>WIZARDS</b> and <b>LOST BOYS</b> .
<b>D2</b>	<b>RESULTS OF COIN TOSS</b>	<b>SCORER</b>
<b>LOST BOYS</b>	Receiving from <b>left</b> court;	1. Record:
<b>WIZARDS</b>	Serving from <b>right</b> court;	a. <b>LOST BOYS</b> in <b>Team</b>
		<b>Info</b> section on <b>LEFT</b> and
		<b>RIGHT</b> sections.
		b. <b>WIZARDS</b> in <b>Team Info</b>
		section on <b>MIDDLE SECTION</b> .



**INFORMATION**

**ACTION**

<p><b>D2 RESULTS OF COIN TOSS</b> Continued</p> <p><b>LOST BOYS</b> Receiving from left court;</p> <p><b>WIZARDS</b> Serving from right court;</p>	<p><b>SCORER</b></p> <ol style="list-style-type: none"> <li>Record in <b>A/B</b> circles:             <ol style="list-style-type: none"> <li><b>A</b> next to <b>LOST BOYS</b>; (On <b>LEFT</b> and <b>RIGHT</b> sections)</li> <li><b>B</b> next to <b>WIZARDS</b>.</li> </ol> </li> <li>Record <b>X</b> through:             <ol style="list-style-type: none"> <li>The <b>(R)</b> for <b>LOST BOYS</b>;</li> <li>The <b>(S)</b> for <b>WIZARDS</b>;</li> </ol> </li> <li>Record <b>X</b> in <b>LOST BOYS Service Rounds</b>, column <b>I</b>, box <b>1</b>.</li> </ol> <p><b>ASSISTANT SCORER</b> Will Record Information On <b>LIBERO CONTROL SHEET</b></p> <p>On <b>LEFT</b> and <b>RIGHT</b> sections:</p> <ol style="list-style-type: none"> <li>Record <b>A</b> in <b>AorB</b> circles.</li> <li>Record <b>LOST BOYS</b> next to <b>Libero</b> boxes.</li> </ol> <p>On the <b>MIDDLE</b> section:</p> <ol style="list-style-type: none"> <li>Record <b>B</b> in <b>AorB</b> circle.</li> <li>Record <b>WIZARDS</b> next to <b>Libero</b> boxes.</li> </ol>																											
<p><b>D3 ROSTERS</b></p> <p><b>LOST BOYS: 9</b> Team Captain;</p> <p><b>WIZARDS:</b> No captain indicated;</p>	<p><b>SCORER</b></p> <p>On <b>LEFT</b> and <b>RIGHT</b> sections: Above <b>LOST BOYS</b></p> <ol style="list-style-type: none"> <li>Record <b>9</b> in <b>CAPTAIN</b> box.</li> </ol> <p>On <b>MIDDLE</b> section: Above <b>WIZARDS</b></p> <ol style="list-style-type: none"> <li>Record <b>X</b> in <b>CAPTAIN</b> box.</li> </ol>																											
<p><b>D4 LOST BOYS LINE-UP SHEET</b></p> <table border="1" data-bbox="165 1104 455 1404"> <tr> <td colspan="2"><b>SET 3</b></td> <td><b>LIBERO N°</b></td> </tr> <tr> <td colspan="2"><b>LINE-UP SHEET</b></td> <td></td> </tr> <tr> <td colspan="2"><b>TEAM LOST BOYS</b></td> <td><b>9c X</b></td> </tr> <tr> <td><b>IV</b></td> <td><b>III</b></td> <td><b>II</b></td> </tr> <tr> <td><b>47</b></td> <td><b>17</b></td> <td><b>8</b></td> </tr> <tr> <td><b>V</b></td> <td><b>VI</b></td> <td><b>I</b></td> </tr> <tr> <td><b>23</b></td> <td><b>2</b></td> <td><b>15</b></td> </tr> <tr> <td colspan="3" style="text-align: center;"><b>SERVICE</b></td> </tr> <tr> <td colspan="3" style="text-align: center;"><b>COACH SIGNATURE</b></td> </tr> </table> <p> <i>Lostboys Boss</i></p>	<b>SET 3</b>		<b>LIBERO N°</b>	<b>LINE-UP SHEET</b>			<b>TEAM LOST BOYS</b>		<b>9c X</b>	<b>IV</b>	<b>III</b>	<b>II</b>	<b>47</b>	<b>17</b>	<b>8</b>	<b>V</b>	<b>VI</b>	<b>I</b>	<b>23</b>	<b>2</b>	<b>15</b>	<b>SERVICE</b>			<b>COACH SIGNATURE</b>			<p><b>SCORER</b></p> <p>On <b>LEFT</b> and <b>RIGHT</b> sections: Next to <b>LOST BOYS</b></p> <ol style="list-style-type: none"> <li>On <b>Libero#</b> boxes:</li> <li>Record:             <ol style="list-style-type: none"> <li><b>9</b> in first box;</li> <li><b>X</b> in second box.</li> </ol> </li> </ol> <p><b>Below LOST BOYS</b></p> <ol style="list-style-type: none"> <li>Record line-up in <b>SERVICE ORDER</b> section.</li> </ol>
<b>SET 3</b>		<b>LIBERO N°</b>																										
<b>LINE-UP SHEET</b>																												
<b>TEAM LOST BOYS</b>		<b>9c X</b>																										
<b>IV</b>	<b>III</b>	<b>II</b>																										
<b>47</b>	<b>17</b>	<b>8</b>																										
<b>V</b>	<b>VI</b>	<b>I</b>																										
<b>23</b>	<b>2</b>	<b>15</b>																										
<b>SERVICE</b>																												
<b>COACH SIGNATURE</b>																												

**INFORMATION**

**ACTION**

**D4 LOST BOYS**  
**LINE-UP SHEET**  
 Continued

SET 3 LINE-UP SHEET		LIBERO N°
TEAM LOST BOYS		9c X
IV 47	III 17	II 8
V 23	VI 2	I 15

SERVICE  
 COACH SIGNATURE  
 *Lostboys Boss*

**SCORER**

On **LEFT** and **RIGHT** sections:  
 Above **LOST BOYS**

4. Record captain:  
 a. **9** in **CAPTAIN** circle.

**ASSISTANT SCORER**

For **LOST BOYS**

5. Record Liberos:  
 a. **9** in L box;  
 b. **X** in R box.

On the **LEFT** and **RIGHT** sections:

6. Record the starting line-up  
 in the **SP** column.

**D5 WIZARDS**  
**LINE-UP SHEET**

SET 3 LINE-UP SHEET		LIBERO N°
TEAM WIZARDS		6 20
IV 4	III 1c	II 3
V 5	VI 7	I 9

SERVICE  
 COACH SIGNATURE  
 *Wizard Leader*

**SCORER**

Next to **WIZARDS**

1. Record, in **Libero#** boxes:  
 a. **6** in first box;  
 b. **20** in second box.

Below **WIZARDS**

2. Record line-up in the  
**SERVICE ORDER** section.

Above **WIZARDS**

3. Record team captains:  
 a. **1** in **CAPTAIN** circle.

**ASSISTANT SCORER**

On **MIDDLE** section:  
 For **WIZARDS**

4. Record Liberos:  
 a. **6** in L box;  
 b. **20** in R box;

5. Record the starting line-up  
 in the **SP** column.

AsB <b>(A)</b> SP	Libero <b>9</b> <b>X</b>	AsB <b>(B)</b> SP	Libero <b>6</b> <b>20</b>	<b>WIZARDS</b>	AsB <b>(A)</b> SP	Libero <b>LOST BOYS</b>
I	15	I	9		I	15
II	8	II	3		II	8
III	17	III	1		III	17
IV	47	IV	4		IV	47
V	23	V	5		V	23
VI	2	VI	7		VI	2

INFORMATION		ACTION	
<b>D6 RECOMMENDED SUBSTITUTION PROCEDURE</b>  <b>ROSTERS ARE NOT USED AT ALL EVENTS</b>  <b>REQUIRED FOR NATIONAL SCORERS</b>	<b>SCORER</b>		
	After comparing the rosters and line-up sheets: The <b>Legal Substitutes</b> are: <b>LOST BOYS: 10, 11</b> <b>WIZARDS: 14, 22</b> 1. Use recorded <b>Legal Substitutes</b> to confirm the substitute (incoming) is legal. On <b>LEFT</b> and <b>RIGHT</b> sections: Below <b>LOST BOYS</b> 2. Record <b>10 11</b> . <b>10</b> was replaced in <b>Set 1</b> using an exceptional substitution. a. Draw a circle around <b>10</b> to indicate that <b>10</b> cannot enter the court. On the <b>MIDDLE</b> section: Below <b>WIZARDS</b> 3. Record <b>14 22</b> .		
LEFT LOST BOYS	MIDDLE WIZARDS	RIGHT LOST BOYS	
(10) 11	Substitutions 1 2 3 4 5 6 7 8 9 10 11 12	14 22	(10) 11
<b>D7 CHECKING LINE-UPS</b> While reviewing the <b>LOST BOYS</b> line-up sheet, 2 <sup>nd</sup> referee notices that <b>Libero 9</b> is the team captain and game captain. Then 2 <sup>nd</sup> referee asks the coach for an alternate game captain (when the <b>Libero</b> is not on the court). The coach indicates that <b>2</b> will be alternate captain. The 2 <sup>nd</sup> referee informs the scorer of the <u>alternate captain</u> .	<b>SCORER</b>		
	On <b>LEFT</b> and <b>RIGHT</b> sections: Above <b>LOST BOYS</b> 1. Record alternate captain: a. <b>2</b> in first slot next to <b>CAPTAIN</b> circle.		
<b>D8 LIBERO REPLACEMENT</b>  After 2 <sup>nd</sup> referee and scorer check <b>LOST BOYS</b> line-up, <b>LOST BOYS Libero 9</b> replaces <b>23</b> . After 2 <sup>nd</sup> referee and scorer check <b>WIZARDS</b> line-up, <b>WIZARDS Libero 20</b> replaces <b>9</b> .	<b>ASSISTANT SCORER</b>		
	On <b>LEFT</b> section only: In <b>LOST BOYS PLAYER</b> section: 1. Record <b>L</b> next to <b>23</b> ; a. <b>Do not</b> slash through <b>23</b> . On <b>MIDDLE</b> section: In <b>WIZARDS PLAYER</b> section: 2. Record <b>R</b> next to <b>9</b> ; a. <b>Do not</b> slash through <b>9</b> .		





INFORMATION	ACTION				
<b>D15 LOST BOYS TIME OUT</b> Continued	2. Show 2 <sup>nd</sup> referee number of time outs taken by each team. At end of time out: 3. Show <b>READY</b> signal				
<b>D16 SUBSTITUTION</b>  <b>LOST BOYS</b> substitute <b>11</b> for <b>2</b> .	<table border="1"> <thead> <tr> <th data-bbox="511 277 915 313">SCORER</th> </tr> </thead> <tbody> <tr> <td data-bbox="511 313 915 727">               For <b>LOST BOYS</b>                On <b>LOST BOYS LEFT</b> and <b>RIGHT</b> sections:                In <b>Legal Substitutes</b> section:                4. Confirm substitute is legal;                5. Slash through <b>2</b> to indicate that <b>11</b> has entered the court.                In <b>Score at Substitutions</b> column <b>VI</b>, first row under <b>2</b>:                1. Record <b>11</b> in left box;                2. Record <b>4:4</b> (score) in right box;                In <b>Substitutions</b> row:                3. Slash through <b>1</b>.             </td> </tr> <tr> <th data-bbox="511 727 915 763">ASSISTANT SCORER</th> </tr> <tr> <td data-bbox="511 763 915 878">               On <b>LEFT</b> and <b>RIGHT</b> sections:                In <b>LOST BOYS PLAYER</b> section:                4. Record <b>11</b> next to <b>2</b>.                5. Slash through <b>11</b>.             </td> </tr> </tbody> </table>	SCORER	For <b>LOST BOYS</b> On <b>LOST BOYS LEFT</b> and <b>RIGHT</b> sections: In <b>Legal Substitutes</b> section: 4. Confirm substitute is legal; 5. Slash through <b>2</b> to indicate that <b>11</b> has entered the court. In <b>Score at Substitutions</b> column <b>VI</b> , first row under <b>2</b> : 1. Record <b>11</b> in left box; 2. Record <b>4:4</b> (score) in right box; In <b>Substitutions</b> row: 3. Slash through <b>1</b> .	ASSISTANT SCORER	On <b>LEFT</b> and <b>RIGHT</b> sections: In <b>LOST BOYS PLAYER</b> section: 4. Record <b>11</b> next to <b>2</b> . 5. Slash through <b>11</b> .
SCORER					
For <b>LOST BOYS</b> On <b>LOST BOYS LEFT</b> and <b>RIGHT</b> sections: In <b>Legal Substitutes</b> section: 4. Confirm substitute is legal; 5. Slash through <b>2</b> to indicate that <b>11</b> has entered the court. In <b>Score at Substitutions</b> column <b>VI</b> , first row under <b>2</b> : 1. Record <b>11</b> in left box; 2. Record <b>4:4</b> (score) in right box; In <b>Substitutions</b> row: 3. Slash through <b>1</b> .					
ASSISTANT SCORER					
On <b>LEFT</b> and <b>RIGHT</b> sections: In <b>LOST BOYS PLAYER</b> section: 4. Record <b>11</b> next to <b>2</b> . 5. Slash through <b>11</b> .					
<b>D17 LIBERO REPLACEMENT</b>  <b>WIZARDS</b> Libero <b>6</b> replaces <b>20</b> .	<table border="1"> <thead> <tr> <th data-bbox="511 878 915 914">ASSISTANT SCORER</th> </tr> </thead> <tbody> <tr> <td data-bbox="511 914 915 1029">               On <b>MIDDLE</b> section:                In <b>WIZARDS PLAYER</b> section:                1. Record <b>L</b> next to <b>R</b>.                2. <b>Do not</b> slash through <b>L</b>.             </td> </tr> </tbody> </table>	ASSISTANT SCORER	On <b>MIDDLE</b> section: In <b>WIZARDS PLAYER</b> section: 1. Record <b>L</b> next to <b>R</b> . 2. <b>Do not</b> slash through <b>L</b> .		
ASSISTANT SCORER					
On <b>MIDDLE</b> section: In <b>WIZARDS PLAYER</b> section: 1. Record <b>L</b> next to <b>R</b> . 2. <b>Do not</b> slash through <b>L</b> .					
<b>D18 LOST BOYS SERVE</b>  <b>LOST BOYS 17</b> contacts the ball  and serves 3 points before serving out of bounds.	<table border="1"> <thead> <tr> <th data-bbox="511 1029 915 1065">SCORER</th> </tr> </thead> <tbody> <tr> <td data-bbox="511 1065 915 1463">               On <b>LEFT</b> section only:                In <b>LOST BOYS Service Rounds</b> column <b>III</b>, box <b>1</b>, under <b>17</b>:                1. Draw small checkmark (✓) through <b>1</b> in upper right corner.                In <b>LOST BOYS Points</b> column:                2. Slash through <b>5-7</b>.                3. Record <b>LOST BOYS</b> Exit Score <b>7</b>.             </td> </tr> </tbody> </table>	SCORER	On <b>LEFT</b> section only: In <b>LOST BOYS Service Rounds</b> column <b>III</b> , box <b>1</b> , under <b>17</b> : 1. Draw small checkmark (✓) through <b>1</b> in upper right corner. In <b>LOST BOYS Points</b> column: 2. Slash through <b>5-7</b> . 3. Record <b>LOST BOYS</b> Exit Score <b>7</b> .		
SCORER					
On <b>LEFT</b> section only: In <b>LOST BOYS Service Rounds</b> column <b>III</b> , box <b>1</b> , under <b>17</b> : 1. Draw small checkmark (✓) through <b>1</b> in upper right corner. In <b>LOST BOYS Points</b> column: 2. Slash through <b>5-7</b> . 3. Record <b>LOST BOYS</b> Exit Score <b>7</b> .					

INFORMATION		ACTION	
D18	LOST BOYS SERVE Continued	SCORER	
		On MIDDLE section: On WIZARDS Points column: 4. Slash through WIZARDS rally point 5.	
D19	WIZARDS SERVE  WIZARDS 1 contacts the ball and serves out of bounds.	SCORER	
		On MIDDLE section: In WIZARDS Service Rounds column II, box 1, under 3: 1. Draw small checkmark (✓) through 1 in upper right corner. 2. Record WIZARDS Exit Score 5. On LEFT section only: 3. Slash through LOST BOYS rally point 8.	
D20	COURT CHANGE  Court change point 8 has been scored.  Teams change courts.  LOST BOYS 47 will be next server.	SCORER	
		On the LOST BOYS RIGHT section: In the Points at Chg circle: 1. Record 8. In POINTS COLUMN: 1. Slash point 8 ONLY. In LOST BOYS Service Rounds, column III, under 17: 3. Record 7. 4. Do not draw small checkmark (✓) through 1 in upper right corner.	
		ASSISTANT SCORER	
		On LOST BOYS RIGHT PLAYERS section: 5. Record L next to 8; a. Do not slash through 8. 6. Notify 2 <sup>nd</sup> referee that both teams have Liberos on court; a. Hold both hands over the table with palms facing table.	
<b>THE LEFT SECTION OF THE SCORE SHEET IS NO LONGER USED</b>			

**INFORMATION**

**ACTION**

<p><b>D21 LIBERO REPLACEMENT</b></p> <p><b>LOST BOYS 8</b> replaces Libero <b>9</b>.</p> <p>Scorer notices that <b>LOST BOYS</b> captains (<b>9</b> or <b>2</b>) are not on the court.</p> <p>2<sup>nd</sup> referee confers with coach, who decides that <b>17</b> will be the alternate captain and informs scorer.</p>	<p><b>ASSISTANT SCORER</b></p> <p>In <b>LOST BOYS PLAYER</b> section:</p> <ol style="list-style-type: none"> <li>Record <b>8</b> next to <b>L</b>;</li> <li>a. <b>Do not slash</b> through <b>L</b>.</li> </ol> <p><b>SCORER</b></p> <ol style="list-style-type: none"> <li>Notify 2<sup>nd</sup> referee that <b>LOST BOYS</b> need a captain.</li> <li>Slash <b>2</b> in <b>CAPTAIN</b> slot.</li> <li>Record <b>17</b> in the next slot.</li> </ol>
<p><b>D22 LOST BOYS SERVE</b></p> <p><b>LOST BOYS 47</b> contacts the ball and scores <b>1</b> point.</p> <p><b>LOST BOYS</b> lose the next rally.</p>	<p><b>SCORER</b></p> <p>In <b>LOST BOYS Service Rounds</b> column <b>IV</b>, box <b>1</b>, under <b>47</b>:</p> <ol style="list-style-type: none"> <li>Draw small checkmark (✓) through <b>1</b> in upper right corner.</li> </ol> <p>In <b>LOST BOYS Points</b> column:</p> <ol style="list-style-type: none"> <li>Slash through <b>9</b>.</li> <li>Record <b>LOST BOYS</b> Exit Score <b>9</b>.</li> <li>Slash through <b>WIZARDS rally point 6</b>.</li> </ol>
<p><b>D23 LIBERO REPLACEMENT</b></p> <p><b>WIZARDS 9</b> replaces Libero.</p>	<p><b>ASSISTANT SCORER</b></p> <p>In <b>WIZARDS PLAYER</b> section:</p> <ol style="list-style-type: none"> <li>Record <b>9</b> next to <b>L</b>;</li> <li>a. <b>Do not slash</b> through <b>L</b>.</li> </ol>
<p><b>D24 SUBSTITUTION</b></p> <p><b>WIZARDS</b> substitute <b>22</b> for <b>4</b>.</p>	<p><b>SCORER</b></p> <p>For <b>WIZARDS</b></p> <p>In <b>Legal Substitutes</b> section:</p> <ol style="list-style-type: none"> <li>Confirm substitute is legal; Slash through <b>22</b> to indicate that <b>22</b> has entered the court.</li> </ol> <p>In <b>Score at Substitutions</b> column <b>IV</b>, first row under <b>4</b>:</p> <ol style="list-style-type: none"> <li>Record <b>22</b> in left box;</li> <li>Record <b>6:9</b> (score) in right box;</li> </ol> <p>In <b>Substitutions</b> row:</p> <ol style="list-style-type: none"> <li>Slash through <b>1</b>.</li> </ol>



INFORMATION		ACTION
D24	SUBSTITUTION Continued	ASSISTANT SCORER
		4. Slash through 4. 5. Record 22 next to 4;
D25	WIZARDS SERVE  WIZARDS 22 contacts the ball and serves 4 points before WIZARDS lose the serve.	SCORER
		In WIZARDS Service Rounds column IV, box 1, under 47: 1. Draw small checkmark (✓) through 1 in upper right corner.  In WIZARDS Points column: 2. Slash through 7-10. 3. Record WIZARDS Exit Score 10. 4. Slash through LOST BOYS rally point 10.
D26	SUBSTITUTION  LOST BOYS substitute 2 for 11.  Note: 17 remains alternate captain even when 2 is on the court.	SCORER
		For LOST BOYS: In Score at Substitutions column VI, first row under 11: 1. Record 2 in left box; 2. Record 10:10 (score) in right box; In Substitutions row: 3. Slash through 2.
		ASSISTANT SCORER
		In LOST BOYS PLAYER section: 4. Slash through 11. 5. Record 2 next to 11;
D27	LOST BOYS SERVE  LOST BOYS 23 contacts the serve.  LOST BOYS loses the rally.	SCORER
		In LOST BOYS Service Rounds column V, box 1, under 23: 1. Draw small checkmark (✓) through 1 in upper right corner. 2. Record LOST BOYS Exit Score 10. 3. Slash through WIZARDS rally point 11.

INFORMATION	ACTION
<p><b>D28 WIZARDS SERVE</b></p> <p><b>WIZARDS 5</b> contacts serve and scores 1 point.</p>	<p><b>SCORER</b></p> <p>In <b>WIZARDS Service Rounds</b> column <b>V</b>, box <b>1</b>, under <b>5</b>:</p> <ol style="list-style-type: none"> <li>1. Draw small checkmark (✓) through <b>1</b> in upper right corner.</li> </ol> <p>In <b>WIZARDS Points</b> column:</p> <ol style="list-style-type: none"> <li>2. Slash through <b>12</b>.</li> </ol>
<p><b>D29 LOST BOYS TIME OUT</b></p> <p><b>LOST BOYS</b> take second time out.</p>	<p><b>SCORER</b></p> <p>In second <b>Time Out</b> box under <b>LOST BOYS Points</b> column:</p> <ol style="list-style-type: none"> <li>1. Record <b>10:12</b> (score).</li> <li>2. Show 2<sup>nd</sup> referee number of time outs taken by each team.</li> </ol> <p>At end of time out:</p> <ol style="list-style-type: none"> <li>3. Show <b>READY</b> signal.</li> </ol>
<p><b>D30 WIZARDS SERVE</b></p> <p><b>WIZARDS 5</b> serves into the net.</p>	<p><b>SCORER</b></p> <ol style="list-style-type: none"> <li>1. Record <b>WIZARDS Exit Score 12</b>.</li> <li>2. Slash through <b>LOST BOYS rally point 11</b>.</li> </ol>
<p><b>D31 LOST BOYS SERVE</b></p> <p><b>LOST BOYS 2</b> contacts serve and scores 2 points.</p>	<p><b>SCORER</b></p> <p>In <b>LOST BOYS Service Rounds</b> column <b>VI</b>, box <b>1</b>, under <b>2</b>:</p> <ol style="list-style-type: none"> <li>1. Draw small checkmark (✓) through <b>1</b> in upper right corner.</li> </ol> <p>In <b>LOST BOYS Points</b> column:</p> <ol style="list-style-type: none"> <li>2. Slash through <b>12-13</b>.</li> </ol>
<p><b>D32 WIZARDS TIME OUT</b></p> <p><b>WIZARDS</b> take first time out.</p>	<p><b>SCORER</b></p> <p>In first <b>Time Out</b> box under <b>WIZARDS Points</b> column:</p> <ol style="list-style-type: none"> <li>1. Record <b>12:13</b> (score).</li> <li>2. Show 2<sup>nd</sup> referee number of time outs taken by each team.</li> </ol> <p>At end of time out:</p> <ol style="list-style-type: none"> <li>3. Show <b>READY</b> signal.</li> </ol>

**INFORMATION**

**ACTION**

<p><b>D33 LOST BOYS SERVE</b></p> <p><b>LOST BOYS 2</b> contacts serve and scores 1 point before losing next rally.</p>	<p align="center"><b>SCORER</b></p> <p>In <b>LOST BOYS Service Rounds</b> column <b>VI</b>, box <b>1</b>, under <b>2</b>:</p> <ol style="list-style-type: none"> <li>1. Draw small checkmark (✓) through <b>1</b> in upper right corner.</li> </ol> <p>In <b>LOST BOYS Points</b> column:</p> <ol style="list-style-type: none"> <li>2. Slash through <b>14</b>.</li> <li>3. Record <b>LOST BOYS Exit Score 14</b>.</li> <li>4. Slash through <b>WIZARDS rally point 13</b>.</li> </ol>
<p><b>D34 WIZARDS SERVE</b></p> <p><b>WIZARDS 7</b> serves the ball into the net to end the match.</p>	<p align="center"><b>SCORER</b></p> <p>In <b>LOST BOYS Service Rounds</b> column <b>1</b>, box <b>2</b>, under <b>15</b>:</p> <ol style="list-style-type: none"> <li>1. <b>Do not</b> draw small checkmark (✓) through <b>1</b> in upper right corner.</li> <li>2. Record <b>WIZARDS Exit Score 13</b>.</li> <li>3. Record <b>LOST BOYS Exit Score 15</b>.</li> </ol>
<p align="center"><b>USE BLUE/BLACK INK</b></p>	
<p><b>D35 SET END TIME</b></p> <p>The set ends at 5:32 PM.</p>	<p align="center"><b>SCORER</b></p> <p>In the <b>End TIME</b> box:</p> <ol style="list-style-type: none"> <li>1. Record <b>17:32</b>.</li> </ol>
<p align="center"><b>FOLLOW ALL POST SET PROCEDURES (E44-E48)</b></p>	
<p><b>D36 SPECIAL POST DECIDING SET PROCEDURES</b></p> <p>Procedures E44-E48 are found in the</p>	<p align="center"><b>SCORER</b></p> <ol style="list-style-type: none"> <li>1. Cancel unused points <b>only</b> in the <b>MIDDLE</b> and <b>RIGHT Points</b> columns.</li> </ol>

**SCORER**  
**END OF MATCH PROCEDURES**

**D37 MATCH RESULTS**

**On All Score Sheets Used For The Match**

In the **MATCH WINNER** box on the upper right corner of the score sheet.

- Record Winning team and **SETS** won and lost.

TEAM	MATCH WINNER Sets W L
<b>LOST BOYS</b>	<b>2 : 1</b>

**D38 SCORE SHEETS REVIEW**

**Check All Score Sheets For Completeness/Accuracy**

- Set numbers are printed or written for all sets.
- Start and End **TIMES** are recorded.
- Number of substitutions matches in all areas.
- Last point recorded in **POINTS COLUMN**.
- Last exit scores entered and circled.
- Unused point are cancelled with **T-Bars**.
- Correct winning and losing teams and scores are entered in all **RESULTS** boxes.
- MATCH WINNER** box completed.

**D39 SIGNATURES**

- Scorer has signed all score sheets.
- 1<sup>st</sup> referee has signed all score sheets.

**D40 PROCESSING COMPLETED SCORE SHEET**

- Process completed score sheets as directed by tournament management.

**FINISHED**

AcrB (A) SP	Libero L 9 R X	LOST BOYS	AcrB (B) SP	Libero L 6 R 20	WIZARDS	AcrB (A) SP	LOST BOYS
I 15			I 9	RL 9		I 15	
II 8 L			II 3			II 8 L 8	
III 17			III 1			III 17	
IV 47			IV 22			IV 47	
V 23 L 23			V 5			V 23	
VI 11			VI 7			VI 2 2	







---

SECTION VII

---

**BASIC USAV  
TOURNAMENT  
PROCEDURES**

## **GUIDELINES FOR CONDUCTING INDOOR TOURNAMENTS/LEAGUES**

To assure maximum efficiency and consistency throughout USA Volleyball in the conduct of sanctioned competition, as well as fair and equitable treatment of teams and players, principles and guidelines have been established by USA Volleyball. These should be considered as the national minimum standard and should be an integral part of the sanction agreement with USA Volleyball and/or the Regional Volleyball Association.

It is recognized that not all organizations and facilities have the minimum resources available to meet these minimum standards continually. In these cases, reasonable alternatives should be provided.

The rules offer many options to allow for a wide range of use. It is the responsibility of the Tournament or League Director to specify in writing which options or modifications to the rules will be enforced. Players must be notified of all Tournament/League Regulations prior to the start of play and preferably before the acceptance of any entries.

Guidelines for specific nationally sanctioned tournaments can be found on the web site at [www.usavolleyball.org](http://www.usavolleyball.org).

### **A. GENERAL INFORMATION**

1. All tournament regulations must be within the guidelines of the governing organization.
2. Common sense may dictate that adaptations to the rules may enhance the playing experience in certain situations.
3. All adaptations to the rules and tournament guidelines must be for the improvement of the game for the participants involved. Principles of fairness and increased participation should guide decisions to adapt playing rules.
4. When in doubt, contact the volleyball authority within your organization.

### **B. APPLICATION/PREPARATION**

1. Tournament Directors should apply for and receive sanction from their respective state, regional or national authority. Requests for any waivers to the rules should be submitted to the appropriate authority at this time or as soon as the need has been determined.



2. Obtain the correct forms and equipment to have available at the site such as:
  - a. Appropriate equipment (nets, standards, antennae, volleyball, etc.) to conduct competition consistent with the rules.
  - b. A copy of the current USAV Volleyball rules book and any specific tournament/league guidelines.
  - c. USA Volleyball score sheets, line-up sheets and Libero control sheets. These may be printed from the website.
3. For large, multi-court tournaments, the following is recommended:
  - a. A non-playing tournament director/manager with the sole responsibility of keeping the tournament on schedule and properly recorded; OR
  - b. A court manager for every 1-4 courts, all of whom are collectively charged with the above responsibilities; AND
  - c. A non-playing certified referee in charge who shall be designated to handle all referee assignments.
  - d. The duties of the Head Referee may include identifying a protest committee and working with the tournament director to identify ground rules. He/she may also be charged with setting a referee schedule when certified match officials are used.
4. For smaller tournaments and leagues, some of these duties may be combined.
  - a. A one-court facility may require only one person to act as the site director and the head referee.
  - b. A two- to four-court facility with a paid referee on each court might require only one tournament/league director, who may also act as head referee.

## **C. FEES/AWARDS**

5. Each tournament situation is unique. The entry fee should be commensurate with expenses incurred. Some considerations should be:
  - a. paid officials,

- b. cost of facilities, equipment and administrative supplies/ costs,
  - c. awards,
  - d. sale of food items, merchandise, etc., to help defray expenses,
  - e. contribution to USA Volleyball Foundation, Endowment Fund or other charity,
  - f. payment of expenses to team(s).
6. Selection of awards is generally dependent upon the number of teams entered, the age of the participants and the financial resources available. Awards may include:
- a. team trophies or plaques,
  - b. individual awards such as medals, plaques, t-shirts or other merchandise,
  - c. money back in the form of expenses or future tournament entry fees.

#### **D. TYPES OF TOURNAMENTS**

1. Double Elimination: Because of the obviously limited play potential for the weaker teams, this type of tournament is discouraged.
2. Round Robin: This is more universally accepted because all teams are guaranteed a reasonable number of sets/matches. It also is more practical for the assignment of support officials. A multi-court round robin in the same division/class will require a championship playoff. A single-court round robin does not require a playoff. Such an arrangement is discouraged.
3. Many large national-level and festival-type tournaments have more than one round of pool play (round robin) culminating in a single- or double-elimination round.

#### **E. SCHEDULING PARAMETERS**

1. Scheduling matches for a tournament must be realistic. These time allowances provide for a six-minute warm-up between matches and three minutes between sets. Usually, only the results of full matches (two out of three or three out

of five 25 rally point sets with the deciding set to 15 rally points) are acceptable for seeding purposes for national-level events. Playing formats may be adjusted to fit the needs of the tournament. For example, if a team drops out at the last moment, three sets to 25 points might be played to ensure that a minimum number of sets are played by the remaining teams.

Two 25 rally point sets.....50 minutes

Two 21 rally point sets.....45 minutes

2/3 25 rally point sets per ... 1 hr. 5 min. match (15-pt. third set)

One 15 rally point set ..... 20 minutes

One 25 rally point set ..... 26 minutes

3/5 25 rally point set 1 hr. 45 min. per match (15-pt. fifth set)

2. At least five additional minutes of warm-up shall be allotted for the first match for each team except in those facilities that provide an adequate warm-up area not in conflict with the playing areas.
3. Teams should play at the announced time when their match is sequentially ready to be played, regardless of the time schedule. The time schedule is only a guideline.  
EXCEPTION: The first match of the day for each team should be governed by the announced/scheduled starting time only. Some large tournaments (national level) may have their own written guidelines for their tournament schedules. For example, it is standard at large junior tournaments for pool play matches to start at the scheduled time with the provision that a match may start no more than 10 minutes early, provided both playing teams and the referees agree.
4. The tournament schedule and forfeit procedures should be clearly posted and all teams informed.
5. Samples of various round robin schedules (officiating team in parentheses): Pool play sequences, listed below, are allowable for use with all respective pools in an NQ, unless another sequence is approved by the Events Department.

## F. METHOD OF PLAY

Round	Four-Team Pools	Three-Team Pools	Five-Team Pools on 2 courts *
Match 1	1 vs. 3 (ref 2)	1 vs. 3 (ref 2)	1 vs. 5 and 2 vs. 4 (ref 3)
Match 2	2 vs. 4 (ref 1)	2 vs. 3 (ref 1)	1 vs. 4 and 2 vs. 3 (ref 5)
Match 3	1 vs. 4 (ref 3)	1 vs. 2 (ref 3)	½ Hour Break
Match 4	2 vs. 3 (ref 1)		1 vs. 3 and 4 vs. 5 (ref 2)
Match 5	3 vs. 4 (ref 2)		2 vs. 5 and 3 vs. 4 (ref 1)
Match 6	1 vs. 2 (ref 4)		½ Hour Break
			1 vs. 2 and 3 vs. 5 (ref 4)

Round	Four-Team Pools court 1 *	Four-Team Pools court 2 *
Match 1	A 1 vs. 3 (ref B3)	A 2 vs. 4 (ref B2)
Match 2	B 1 vs. 3 (ref A3)	B 2 vs. 4 (ref A4)
Match 3	A 2 vs. 3 (ref B3)	A 1 vs. 4 (ref B4)
Match 4	B 2 vs. 3 (ref A2)	B 1 vs. 4 (ref A4)
Match 5	A 1 vs. 2 (ref B4)	A 3 vs. 4 (ref B1)
Match 6	B 3 vs. 4 (ref A1)	B 1 vs. 2 (ref A3)

## JNC FORMAT

Round	Four-Team Pools	Three-Team Pools	Five-Team Pools on 2 Courts
Match 1	1 v 3 (ref 2)	1 v 3 (ref 2)	1 v 5 and 2 v 4 (ref 3)
Match 2	2 v 4 (ref 1)	2 v 3 (ref 1)	1 v 4 and 2 v 3 (ref 5)
Match 3	1 v 4 (ref 3)	1 v 2 (ref 3)	1/2 Hour Break
Match 4	2 v 3 (ref 1)		1 v 3 and 4 v 5 (ref 2)
Match 5	3 v 4 (ref 2)		2 v 5 and 3 v 4 (ref 1)
Match 6	1 v 2 (ref 4)		1/2 Hour Break
Match 7			1 v 2 and 3 v 5 (ref 4)

## (ONE-DAY TOURNAMENTS)

- When round robin competition is scheduled, a maximum of five teams only should be accepted per available court.
- When round robin play qualifies teams for a championship playoff, no more than 50 percent of the teams entered should advance to the championship playoff bracket.
- The championship bracket is recommended not to exceed eight teams.
- When two four-team brackets are scheduled, a championship and consolation pool may be formed from a first-round robin competition. Subsequent competition utilizing the top two and bottom two teams will determine first, second, third from the championship pool and fourth place by winning the consolation pool.
- In round robin play the following will prevail:
  - If five teams are entered and a championship play-off is scheduled, matches may consist of either two 21 rally point

sets or two 25 rally point sets. Time might not allow the use of either the best of three or three-set matches.

- b. If five teams are entered and a championship play-off is not scheduled, matches may consist of either two 21 rally point sets or two 25 rally point sets. Time may not allow the use of the best of three or three-set matches.
  - c. If four teams are entered, matches may consist of any format, as long as it meets a reasonable time frame and is fair to all team entries proportionate to their entry fee and travel time. Some options include four-team pool play three sets to 25 rally points or best two-out-of-three 25 rally point sets (15 rally point third set).
  - d. Where there is only one pool, and a total round robin is scheduled, additional matches are not recommended. If a championship playoff is scheduled, the following criteria should be met:
    - 1) Projected time schedule will permit such additional scheduling.
    - 2) Playoffs should be restricted to the first- and second-place teams only.
    - 3) The second-place team should win at least 75 percent of its sets in round robin competition.
6. Finals should be scheduled to begin no later than 9 p.m. and earlier if possible.

## **G. WARM-UP PROCEDURES ADULT COMPETITION:**

1. Usually, because of limited time, the teams preparing to play the next match must be ready to take the court immediately at the end of the previous match. Warm-up time for the teams vary from 5 to 10 minutes, depending on the tournament guidelines.
2. After the coin toss, one of the following warm-up procedures is specified:
  - a. The warm-up time is split evenly in two, with the serving team taking the court for the first half and the receiving team taking the court for the second half. The teams may use the entire court in whatever manner they choose during

their time, including serving practice.

- b. Shared hitting - both teams using the court to practice hitting at the net. The court should be split down the middle, perpendicular to the net so that the teams are hitting from their left side and down the line. Each team may practice blocking its own players. For the safety of the players, the referees should monitor that teams are not hitting into each other. If the teams are unable or unwilling to control their hitting, the referee would have the teams revert to option a or c.
- c. A variation of “a” and “b” is to allow both teams to serve together for the last minute or two of the warm-up period. For example, if the total warm-up time is five minutes, the teams would share the court for four minutes and serve together for one minute (option a) or each would use the court for two minutes separately and then serve together for one minute (option b).

#### JUNIOR COMPETITION:

1.1 For National Junior Volleyball events, the 2-4-4 format is typically used. The first two minutes are for ball handling on a team's own side of the court, followed by four minutes of the entire court use by the serving team and then 4 minutes for the receiving team. When one team has use of the full court, the opponent must be at their team bench or may offer to retrieve practice balls to assist the team on the court. Serving is conducted during each team's four minutes. Shared hitting/serving is prohibited at Junior events.

### **H. GENERAL GUIDELINES FOR THE DETERMINATION OF PLAYOFF POSITION(S) IF TIED**

1. Teams qualifying for the playoffs, but tied for position only, should not compete in a playoff set to determine position; rather, position assignment should be determined by the priority system listed below based on point differential to the extent possible.
  - a. Results of the match(es) between the tied teams, first on the won- lost record, and second on the point spread. If still tied, then;

- b. comparison of the point differential based on the total round robin competition. Point differential should be determined by subtracting the total points lost from the total points won. The highest plus or the lowest minus remainder should be considered the superior team for tie-breaking purposes. If still tied, then;
  - c. coin toss.
2. If there are more teams tied for the playoffs than there are positions, the tied teams must compete for the position(s) in further direct competition. Teams should NOT be eliminated from assignment to championship competition by point differential or any other non-competition system.
  3. If two or more teams are tied for a single playoff position, the minimum number of one additional 25 rally point set should be played. Teams should change sides at 13 points. No cap shall be in effect. Where tournament guidelines stipulate, 15-point sets may be used. For example:
    - a. Two teams tie for last position: One 25 rally point set.
    - b. Three teams tie for last position: Superior as determined by the criteria in H1 shall be the bye team and play the winner of the match between the two remaining teams. Two 25 rally point sets total.
    - c. Four teams tie for last position: As determined by the criteria in H1, team 1 vs. 4, 2 vs. 3 and winners play off. Three 25 rally point sets total.
  4. If three teams tie for two playoff positions, the team with the greater point spread shall be awarded first place. The other two teams shall play one 25 rally point set for the remaining playoff position. The same priorities as listed in H1 shall prevail, except that if a tie shall exist after the second priority, the flip of a coin shall determine the bye team, and all teams must play for position as follows:
    - a. Team Blue wins over Team White and gains one playoff berth.
    - b. Team Red plays the loser, in this case Team White, for the second playoff berth. Two 25 rally point sets total.

5. These are only guidelines. Other methods are acceptable, as long as they are printed and distributed before the start of the event.

## **I. DUTIES OF COURT MANAGERS**

1. The court manager is responsible for getting matches and officials on and off the court.
2. The officials for each match at major tournaments include a 1st referee, 2nd referee, scorer, assistant scorer, timekeeper/visual scoreboard operator and two line judges. The court manager needs to check equipment (nets, standards, volleyballs, antennae, etc.) to make certain they are in good condition at all times.

## **J. PROCUREMENT/ASSIGNMENT OF REFEREES**

1. Competition should be duly certified USA Volleyball referees unless otherwise approved by the Regional Referees Chair.
2. Non-player certified referees, as well as available certified player referees, may be used in all sanctioned competition.
3. All non-player USAV certified referees are required to wear the approved volleyball officials' uniform.
4. All match assignments shall be made by the designated Head Referee. In the absence of a Head Referee, the Tournament Director will act in this capacity.
5. Other organizations that sponsor volleyball activities may want to contact the USA Volleyball Regional Commissioner or Referees Chair to obtain clinic and certification information and gain access to the USA Volleyball certified officials in the area.

## **K. ASSIGNMENT OF SUPPORT OFFICIALS**

1. The primary responsibility for the assignment of support officials should lie with the Tournament Director.
2. Participating teams may be expected to furnish required support officials as requested. Required officials are the 2nd referee, the scorer, the assistant scorer, two line judges and visual score board operator. It is recommended that only USA



Volleyball certified scorers should serve in the capacity of scorer.

3. A working schedule, including playoff sets, should be posted prior to the first match of the day so teams will be properly informed as to respective responsibilities. In addition, teams assigned to work the first scheduled matches should be notified at least three days in advance of the tournament. Those work teams failing to meet this obligation may be subject to discipline within their organization.
4. As part of item “3” above, teams playing in the final round robin match of the day, if not otherwise a participating team, will be assigned to the first level of the playoff matches. Losers of the play-off matches will be required to work the next level of the playoffs. Teams not fulfilling these assignments may be subject to discipline within their organization.
5. Any penalties for teams that do not fulfill their officiating responsibilities should be posted prior to play. One commonly used method is to penalize the assigned officiating team one point per minute up to a maximum of 25 points (one set), which would be imposed at the beginning of the team’s next match. The penalty points would begin at the start of the second team’s warm-up period.

## GUIDELINES FOR DEALING WITH BLOOD

If a player incurs an injury that causes bleeding, the 1st or 2nd referee shall immediately stop play in accordance with USAV 17.1.1. The player shall leave the court for evaluation/treatment. If the player cannot continue play and must be replaced, this should be done within the guidelines of USAV 15.6 or USAV 15.7. If substitution cannot be made, refer to USAV 17.1.2. If a player’s uniform becomes saturated with blood, a change of uniform will be authorized. This change should be accomplished as quickly as possible to cause no additional delay to the resumption of play. The replacement uniform should be of a similar color and style. Though duplicate numbers will not be allowed, no sanction will be assessed if the player’s replacement uniform number is different than the original number. If a replacement uniform is not available, the player must be replaced by a legal substitution. If the referee observes blood on the playing surface or equipment, play shall be stopped immediately and measures taken to clean any contaminated area or equipment using universal precautions.

## CONCUSSION GUIDELINES

The following guidelines from the Center for Disease Control (CDC) are offered to assist coaches, parents, tournament staff and officials in identifying concussion symptoms.

### HOW CAN A SPORTS OFFICIAL, COACH OR PARENT SPOT A POSSIBLE CONCUSSION?

Athletes who show or report one or more of the signs and symptoms listed below—or simply say they just “don’t feel right” after a bump, blow, or jolt to the head or body—may have a concussion or other serious brain injury.

- Appears dazed or stunned.
- Forgets an instruction, is confused about an assignment or position, or is unsure of the game, score, or opponent.
- Moves clumsily.
- Answers questions slowly.
- Loses consciousness (even briefly).
- Shows mood, behavior, or personality changes.
- Can’t recall events prior to or after a hit or fall.

### SYMPTOMS REPORTED BY ATHLETES

- Headache or “pressure” in head.
- Nausea or vomiting.
- Balance problems or dizziness, or double or blurry vision.
- Bothered by light or noise.
- Feeling sluggish, hazy, foggy, or groggy.
- Confusion, or concentration or memory problems.
- Just not “feeling right,” or “feeling down.”

## AMERICAN SIGN LANGUAGE (ASL) INTERPRETER GUIDELINES

- An ASL interpreter who meets all requirements of an assistant coach is afforded the rights and responsibilities of an assistant coach.
- An ASL interpreter, who is not a coach, may sit on the team bench during the match and may participate in any team activities afforded other rostered team members.
- Per the Americans with Disabilities Act (ADA), the requirement of “effective communication” between coach and athlete can be achieved one of two ways: (a) the ASL interpreter who meets all requirements of an assistant coach is allowed to go anywhere, during the play, that the coach goes, or (b) the coach needs to adjust her/his coaching style to ensure that she/he is always within sufficient distance of the interpreter to facilitate interpreting.
- In all cases, anyone serving in the role of ASL interpreter will have frequent contact with and/or authority and control over junior athletes, and therefore, must be a USAV member with a clear background screen and must have completed SafeSport training.

## ABBREVIATIONS

m	=	meter
'	=	foot (feet)
cm	=	centimeter
”	=	inches
gm	=	grams
mbar	=	millibars
kg/cm <sup>2</sup>	=	kilograms per square centimeter
lbs/sq in	=	pounds per square inch
lbs/sq in	=	68.0 mbar = 0.0703 kg/cm <sup>2</sup>
°C	=	degrees Celsius
°F	=	degrees Fahrenheit

## METRIC CONVERSIONS

Length of playing court	18 m = 59'
Width of playing court	9 m = 29'6"
Diagonal of half the playing court	12.728 m = 41'8 1/2"
Minimum length of net	9.5 m = 32'
Minimum width of free zone	3 m = 9'10"
Recommended height of post	s2.55 m = 8'4"
Height of men's net	2.43 m = 7'11 5/8"
Height of women's net	2.24 m = 7'4 1/8"
Height of 12 & under net	2.13 m = 7'
Height of 10 & under net	1.98 m = 6'6"
Length of antenna	1.8 m = 5'11"

Net width:

Max. sideline – post distance	1 m = 39"
Length of antenna above net	0.8 m = 32"
Circumference of ball	65-67 cm = 25 1/2-27"
Referee's view above net	50 cm = 19 1/2"

Max. distance of net height

From sideline to center	2 cm = 3/4"
Min. temperature	10° C = 50° F
Weight range of ball	260-280 gm = 0.5-0.6 lb
Internal air pressure of ball (indoor)	0.30-0.325 kg/cm <sup>2</sup> = 4.3-4.6 lb/sq in
Internal air pressure of ball (outdoor)	0.175-0.225 kg/cm <sup>2</sup> = 2.5-3.2 lb/sq







---

## INDEX

---

# Index

## #

2nd referee ..... 38, 134, 144

## A

Adjacent Courts ..... 50

American Sign Language interpreter ..... 33, 256

Antennae ..... 30, 49, 52, 53, 54, 117, 118, 142, 247, 254

Assistant Coach ..... 9, 138, 257

Assistant Scorer ..... 89, 90, 130, 137, 143, 144, 202, 254

Attack Hit

Characteristics, Restrictions, Faults ..... 58

Involving the Libero ..... 72

## B

Back-Row Faults

Attack Hit ..... 59, 102

Blocking ..... 61

Involving the Libero ..... 72

Ball Crossing the Net ..... 52

Ball "In" ..... 48

Ball "Out" ..... 48

Ball Touching the Net ..... 52

Block

Block and Team Hits ..... 50, 53, 60

Blocking Faults ..... 60

Definition ..... 59

Within the Opponent's Space ..... 60

Blood Guidelines ..... 255



## C

Captain .....	38, 39, 130, 132, 133, 135, 137
Center Line	
Dimensions .....	27
Penetration .....	53
Change of Courts .....	70, 87
Coach .....	38
Location .....	34, 39
Team Composition .....	33
Coin Toss .....	130, 135, 142
Competition Control Area .....	78
Concussion Guidelines .....	256
Contact with the Net .....	53
Court .....	28, 29
Dimensions .....	27
Equipment .....	30
Lines and Markings .....	27
Zones and Areas .....	27

## D

Default and Incomplete Team .....	41
Delay Sanctions .....	68, 73, 137
Disqualification .....	77, 78
Double Fault .....	40, 59, 61, 83, 113

## E

Exceptional Substitution .....	64, 65
Expulsion .....	77, 78
External Interference .....	48, 49, 69

## F

Faults in Playing The Ball .....	51
First Referee .....	76, 130
Authority .....	83, 84
Location .....	83
Responsibilities .....	84, 85
First Service in a Set .....	55
Forbidden Objects .....	36

## G

Game Delays .....	67
Game Interruptions .....	62, 67, 68

## H

Height of the Net .....	28
-------------------------	----

## I

Improper Request .....	66, 67, 114, 140
Inadvertent Whistle .....	48
Injury/Illness .....	68
Interference .....	69, 140
Interruptions .....	62, 67, 68
Intervals .....	34, 70

## J

Jewelry .....	140
---------------	-----

## L

Libero 71, 139	
Actions Involving the Libero 5 .....	9, 72
Designation .....	71
Re-Designation .....	74, 75
Replacements .....	72, 73
Serving .....	46, 72

Libero Control Sheet .....	200
Lighting .....	28
Line Judges .....	82, 90
Flag Signals .....	115
Location and Position .....	90, 137
Responsibilities .....	91, 140

## M

Media Personnel and Equipment .....	49
Misconduct and Its Sanctions .....	76
Before and Between Sets .....	78

## N

Net and Posts .....	28, 29, 30, 31
---------------------	----------------

## O

Official Signals .....	91
------------------------	----

## P

Player at the Net .....	53
Penetration Under the Net .....	53
Reaching Beyond the Net .....	53
Player Positions .....	45
Player's Faults at the Net .....	54
Player's Uniform and Equipment .....	34, 35, 139
Playing Area .....	26, 49, 50
Playing Format .....	40
Playing Surface .....	26, 50, 55
Playing the Ball .....	50
Portable Playing Surface .....	55
Positional Fault .....	45, 46, 58, 136
Prolonged Interruptions .....	69
Protest Procedures .....	37, 38
Protest Procedures .....	147
"Pursuit Rule" .....	52

## R

Referee Equipment .....	142
Refereeing Corps .....	82, 83
Referees' Hand Signals 1 .....	05
Referee Stand .....	31
Replay .40, 48, 49, 52, 59, 61	
Rotation .....	46
Rotation and Rotational Fault .....	46, 47

## S

Sanctions Scales .....	77, 103
Score a Point .....	40
Scorer ..82, 88, 89, 90, 130	
Scoring Procedures .....	151
screening .....	144
Screening .....	56
Second Referee .....	82, 85, 144, 145, 146
Authority .....	83, 85, 86
Location and Position .....	85, 131
Responsibilities .....	43, 82, 83, 87, 130, 131, 132, 133, 134, 135, 145, 146
Service .....	55
Authorization .....	55
Execution .....	56, 57, 58
Faults .....	57, 58
Positional Faults During the Serve .....	58
Service Order .....	46, 55, 57
Set Intervals .....	34, 70
States of Play .....	48
Structure of Play .....	42
Substitution .....	62, 63
For Expulsion or Disqualification .....	65
Illegal .....	45, 65
Limitation of Substitutions .....	63
Multiple or Simultaneous Substitutions .....	133
Substitution Procedure .....	66, 133

## T

Team Hits .....	50
Faults .....	51
Simultaneous .....	51
With Blocking .....	61
Teams	
Composition .....	33
Incomplete Team .....	41
Location .....	34
Roster .....	33, 130
Team Leaders .....	37
Uniform Requirements .....	35, 36
Temperature .....	28, 258
Three-Ball System .....	32
Time-Outs	
Administration .....	132
Duration and Limitations .....	63
Requesting .....	38
Special Injury Time-Out .....	69

## U

Uniform Requirements .....	34, 36
----------------------------	--------

## W

Warm-up Session .....	42, 138
-----------------------	---------











